

# Homeowner's Packet

"Getting Started"

or

"I Wish I Had Read This Booklet When I Moved Here"



"The place you want to go,  
when you need to know"

## Custer County Planning and Zoning

(located in the North Annex of the Custer County Courthouse)

205 S. 6th Street

P. O. Box 203

Westcliffe, CO 81252

(719) 783-2669

(719) 783-9907 (FAX)

[www.custercountygov.com](http://www.custercountygov.com)



# Table of Contents

Things you need to know .....	1
Living in Custer County .....	3
Introduction.....	3
Access.....	3
Utility Services.....	5
The Property.....	7
Mother Nature .....	9
Agriculture .....	11
Carbon-Monoxide Detectors .....	12
Energy Star tax incentives .....	12
911 Questionnaire Notice.....	12
Conclusion.....	12
Local Services Information.....	13
Zoning Permit Approval Procedure.....	16
Use Tax Instructions .....	16
Fee Schedule .....	17
Example of a Plot Plan.....	18
Building Height Regulation.....	19
Example of an Elevation Drawing.....	19
Factory Built Home and RV Ordinance.....	20
Transporting and Selling of Factory Built Homes .....	20
Septic Permit Approval Procedure.....	21
Septic Contractors.....	22
Perc Technicians.....	23
Water Commissioners.....	23
Septic System Operation and Maintenance .....	24
Winterizing Plumbing .....	26
Cistern / Water Storage .....	27
Wet Mountain Fire Protection District Cistern Specifications .....	28
Road and Bridge Specifications for Driveway Installation .....	30
Mailbox Installation along Publicly Maintained Rights-of-Way .....	30
Important Notice Regarding Private Roads .....	30
State Plumbing and Electrical Permit Information .....	31
Compliance Inspection.....	31
Right to Ranch and Farm.....	32
Building Renovation and Demolition .....	33
Creating Wildfire-Defensible Zones .....	35
Fire-Resistant Landscaping .....	41
Dark Skies.....	45
Mountain Pine Beetle .....	47
Colorado State University Extension Office.....	49
CUSTER COUNTY Reverse 911 Emergency Alerts Form .....	End of Packet



# Things you need to know!

You were probably attracted to Custer County because of one or more of the following: The mountain landscape, abundance of wildlife, proximity to National Forest and Wilderness Areas, and undeveloped landscapes in the County. The recreational opportunities or the community itself, both agricultural and artistic might have appealed to you. Most likely you were drawn to the abundant open spaces that provide wildlife habitat and long vistas of verdant hay fields and grazing cattle.

In the heart of the county is the Wet Mountain Valley. The dramatic scenery and wide open views define a very special environment, unique even by Colorado standards. Time and again people recount their experience of coming over the ridge for the first time to see the splendor of the Wet Mountain Valley spread out before them, framed by the dramatic back-drop of the Sangre de Cristo mountain range.

Rural living is nothing like living in the city or suburbs and cannot be treated the same. Those who have moved away from the hassles of the city must understand they will no longer have some of the conveniences of living in the city. The transition is one of education and discovery.

Throughout this document, you will see the following codes:

- \* FYI This will direct you to facts about the subject found elsewhere in the document or hints concerning the subject;
- ? FAQ This indicates Frequently Asked Questions about the subject being discussed. i.e., "Where is the nearest Nordstrom's?" In Denver, about 200 miles from Custer County.

Besides this document, you should also familiarize yourself with the Custer County Zoning Resolution. The resolution alerts you to the rules to follow about your property and what is allowed and disallowed when you build here.

The Custer County Zoning Resolution allows one single family dwelling per parcel regardless of the parcel's size. Uses by right in all Zoning Districts are farming and ranching, one residential dwelling, and accessory buildings. All other uses require a Special Use Permit (SUP) or Planned Unit Development (PUD.) All structures must be fifty feet (50') from all property lines on properties of three acres or ore, twenty-five feet (25') on properties less than three acres but more than one-half acre. A survey is needed for setbacks of ten feet (10') on properties less than one-half acre. The height limit for all structures is thirty feet (30').

\* See page 19

Zoning permits are required on all structures before excavation is started even though Custer County has not adopted a building code. State electrical, plumbing and septic codes have been adopted and shall be followed. The electric and plumbing permits must be obtained from the state. \* See page 33. The electrical and plumbing will be inspected by State Inspectors and the septic system by Inspectors from this office. It is up to you to make sure the structure is built to whatever your specifications may be. As the homeowner you are responsible for what is done by your contractor or subcontractors, and for seeing that all permits are applied for. It is the land owners' responsibility to make sure that all State and County regulations are adhered to.

Colorado's rural areas are undergoing increasingly greater development. More people are building homes in forests or brush lands to take advantage of these natural environments. Often, these sites are quite remote. However, people moving from urban settings expect traditional fire and other emergency services. They do not understand the fire protection limitations that exist in rural areas:

The Custer County fire department is volunteer. Firefighters and ambulance attendants are not generally present at the fire station. In addition, the number of firefighters able to respond may be limited, especially during daytime hours during the traditional work week.

Response time may be quite long. Volunteers must reach the fire station from home or work, start the emergency vehicles and drive to the fire or medical emergency scene, which may be quite far from the station.

Firefighting, water supplies and emergency equipment are limited. Often, the only significant water supply is that which the fire trucks carry. Water shuttles or refill locations must be established and coordinated.

Narrow, steep roads and driveways may limit or even prevent access by emergency equipment. Bridges may have weight limitations that prevent large trucks and tankers from reaching the emergency.

When a wildfire does strike, it can occur with little warning and spread quickly. Fire crews and equipment are often overwhelmed by the task of fighting a rapidly advancing wildfire. There simply may not be enough personnel and equipment to defend every home.

We offer these comments in the sincere hope they will make your decision to reside in Custer County less stressful. It is not our intent to dissuade you, only inform you. It is up to you to read this and other suggested booklets to assist you in the adjustments to life in Custer County. Learn from the experiences of others.

### **Other documents you should read:**

\_\_\_\_\_ Custer County Weed Management Plan (available at Extension Office)

\_\_\_\_\_ Various informative pamphlets located in the Zoning Office, including info on radon, 911, living with wildlife

# Living in Custer County

The *Code of the West* was first chronicled by the famous western writer Zane Grey. The men and women who came to this part of the country during the westward expansion of the United States were bound by an unwritten code of conduct. The values of integrity and self reliance guided their decisions, actions and interactions. In keeping with that spirit, we offer the following information to help the citizens of Custer County follow in the footsteps of those rugged individualists.

## Introduction

It is important to know that life in a rural environment is different from life in the city. County governments are not able to provide the same level of service as city governments. To that end, we are providing you with the following information to help you make an educated and informed decision in purchasing rural land or living in a rural county. It is our intention to let you know what Custer County has that you may have in the city and also to inform you as to what may not be readily available.

- \* You bought land here because of the rural atmosphere. Learn to accept it and live with it. Remember: "You pay a price to live in paradise."

## Access

The fact that you can drive to your property does not necessarily guarantee that you, your guests or emergency service vehicles can achieve that same level of access at all times. Please consider:

- 1.1 There can be problems with the legal aspects of access, especially when you gain access across property belonging to others. It is always wise to obtain legal advice and understand the easements that may be necessary, when these types of questions arise.
  - 1.2 You can experience problems with the maintenance and cost of maintenance of your road. Custer County maintains over 350 miles of roads. Many rural properties are served by private and public roads maintained by private Home Owner Associations (HOA) or Property Owner Association (POA.) There are some county roads that are not maintained by the county - no grading or snow plowing. There are even some public roads that are not maintained by anyone! Be certain you know what type of maintenance to expect and who will provide that maintenance. Realize that sometimes that is you!
- \* If you are in a HOA/POA, ask your neighbors their opinion of the road maintenance provided by the association. If you are not in a HOA/POA, check to see if Custer County Road and Bridge is responsible to grade and snowplow and how often it is done.
- 1.3 Extreme weather conditions can destroy roads. It is wise to determine whether or not your road was properly engineered and constructed. It is advisable to have roads and driveways built up instead of "cut in." Roads that are "cut in" will be harder to keep open in the winter and will become "mud bogs" in the spring, resulting in rapid deterioration and higher maintenance costs.
  - 1.4 Many large construction vehicles cannot navigate small, narrow roads. If you plan to build, it is prudent to check out construction access. For this reason, as well as for emergency vehicle access, such as ambulance, fire trucks and snow plows, road access and driveways should be a minimum of sixteen feet (16') wide.
- ? "My driveway winds through our trees and is always icy in the winter. What can I do?"

Winding driveways are nice, but if tree lined, the sun can't get through to melt the ice. Don't forget, south facing is the ideal direction because snow melts faster. Try to have the main entrance of the house, garage doors and driveway face south to take advantage of the sunlight.

1.5 School buses travel only on maintained county roads that have been designated as school bus routes by the school district. You may need to drive your children to the nearest designated county road so they can catch a school bus.

1.6 In extreme weather, even county maintained roads can become impassable. You may need a four-wheel drive vehicle with chains for all four wheels to travel during those times. Most storm systems tend to only last for a few days and then the sun returns.

? "When will my road be paved?"

Custer County came into existence in 1877 and the first roads were not paved until 1963. Paving roads is not high on the budget precedence, maintaining the present roads is the major priority. Consider a four-wheel drive vehicle and carry a set of chains for all four wheels for travel during those rare extreme weather days. Or, stay home and enjoy the view. Also, when a seller of any property makes a statement that indicates unpaved roads will be paved, check with the Road and Bridge Department.

1.7 Natural disasters, especially floods, will destroy roads. Custer County will repair and maintain county roads, however, most subdivision roads are the responsibility of the landowners who use those roads. A dry creek bed can become a raging torrent and wash out roads, bridges and culverts. Residents served by private roads and/or bridges have been hit with large bills for repairs and/or reconstruction after floods.

\* Your subdivision could charge you an extra assessment to repair the damage. Review the Protective Covenants and By-laws for your HOA/POA.

1.8 Unpaved roads generate dust. When the amount of traffic reaches specific levels, Custer County treats county maintained roads to suppress the dust, but dust is still a fact of life for most local residents.

1.9 If your road is unpaved, it is highly unlikely that Custer County will pave it in the foreseeable future. Check carefully with the County Road and Bridge Department when any statement is made by the seller of any property that indicates any unpaved roads will be paved!

1.10 Unpaved roads are not always smooth and are often slippery when wet. You will experience an increase in vehicle maintenance costs when you regularly travel on rural county roads, (i.e., tires, windshields, air filters and oil changes.)

1.11 Mail delivery is not available to all areas of the county. Ask the postmaster to describe the system for your area.

\* Refer to page 30 for information about personal mailboxes.

1.12 Newspaper delivery is not always available to rural areas. Check with the newspaper of your choice before assuming it will be delivered to your home.

1.13 Standard parcel and overnight package delivery can be a problem for those who live in the country. Confirm with the service providers as to your status for home delivery or in making "drop-off" arrangements in town.

\* There is rarely "overnight delivery" for mail or parcels to or from Custer County. Plan on two or three days at best.



## Utility Services

Approximately 70 percent of properties in the county are in scattered rural areas and people residing on these properties must depend on private wells for drinking water, and septic systems instead of sewers. Only the towns of Westcliffe and Silver Cliff have municipal water and septic services. Electric, telephone (land lines and cell) DSL, Wi-Fi and other services may be unavailable or may not operate at urban standards. Repairs and installations often take longer than in towns and cities. Please review your options from the non-exhaustive list below.

\* Remember, “patience is a virtue” and “plan ahead.”

2.1 TELEPHONE Communications can be a problem, especially in the mountainous areas of Custer County. Some service may not be available except at a high installation cost. If you have a private line, it may be difficult to obtain another line for FAX or computer modem use. Dial-up modems may work at slower speeds than you are accustomed to. Even cell phones do not operate in all areas.

\* Check with providers and your neighbors for suggestions about which services work best for your neighborhood.

2.2 SEWER, if available to your property, may be expensive to hook into the system.

2.3 If sewer service is not available to your property, you will need to use a permitted Custer County septic system or other approved treatment process. The type of soil you have available for a leachfield will be very important in determining the cost and function of your system. Ask for assistance from the Custer County Planning and Zoning Office.

\* Refer to page 24 for a description of a septic tank and handy hints on how to maintain the system and operate it efficiently. Page 27 contains a chart suggesting when septic tank pumping should be done. Murphy’s Law states, “If your septic is going to fail, it is going to happen on a weekend or holiday in the winter.”

? Does a septic system require a permit from Custer County?

Yes, along with an inspection after the septic is installed and before it is backfilled. Page 17 of this document includes the fee schedule for septic systems. Pages 22-23 list County approved Septic Contractors. Subsequent changes to your dwelling, including adding bedroom(s) and/or the addition of a garbage disposal, will require a larger septic system and a septic modification permit.

2.4 WATER The most common method is use of a water well. Permits for wells are granted by the state engineer and the cost for drilling and pumping can be considerable. The quality and quantity of well water can vary from location to location and from season to season. It is strongly advised that you research this issue very carefully. If you own the property and have the luxury of time before you build, you might have your well drilled in a location near the proposed homesite to determine how much water you can expect in gallons per minute and water quality.

\* Check with your neighbors about their experience with well depth, quality and quantity of the water in your neighborhood, but realize that your results may be different. You may have your water quality tested for bacterial content and/or to evaluate water quality for domestic consumption. Pick up a mail-in test kit at the Planning and Zoning Office for the bacterial test or at the extension office for water quality. It is a good idea to have this done annually.

2.5 It is advisable to have a cistern installed to store water. A minimum of 1,000 gallons is recommended. This cistern will serve as a reservoir for domestic use and fire fighting. For fire fighting, a 2 ½ inch riser for residential or 4 ½ inch riser for commercial should be used. An easy access lid would be helpful. Installing a

cistern may reduce your homeowners' insurance premium and will greatly aid fire fighters in controlling any fires in your area. See pages 27-29

2.6 Not all wells can be used for watering of landscaping and/or livestock. Permits from the state engineer may restrict water use to the inside of a home only, on properties of less than 35 acres. If you have other needs, make certain that you have the proper approvals before you invest. It may also be difficult to find enough water to provide for your needs even if you can secure the proper permit.

2.7 ELECTRIC Service is not available to every area of Custer County. It is important to determine the proximity of electrical power. It can be very expensive to extend power to remote areas. Solar power and wind generators are alternative power sources.

\* If your property falls within a HOA/POA, check the Protective Covenants and By-laws for the policy on tap fees and also verify if electricity is readily accessible.

2.8 It may be necessary to cross property owned by others in order to extend electric service to your property in the most cost effective manner. It is important to make certain that the proper easements are in place to allow lines to be extended to your property.

2.9 Electric power may not be available in two phase and three phase service configurations. If you have special power requirements, it is important to know what level of service can be provided to your property.

2.10 If you are purchasing land with the plan to build at a future date, there is a possibility that electric lines (and other utilities, i.e., water) may not be sufficient to meet your needs, if others connect or drill wells during the time you wait to build.

2.11 The cost of electric service is usually divided into a fee to hook into the system and then a monthly charge for energy consumed. It is important to know both costs before making a decision to purchase a specific piece of property.

2.12 Power outages can, and do, occur in outlying areas as well as in more developed areas. A loss of electric power can interrupt your supply of water from a well; may cause the loss of food in freezers or refrigerators; and cause problems with computers and FAXes as well.

\* It is important to be able to survive for up to a week in severe cold with no utilities if you live in the country. This means extra food, water and an alternative heat source. Many people have budgeted a back-up generator (propane or solar powered) hooked-up to essentials, i.e., well, refrigerator, freezer, water heater and furnace.

? What do we do if we are part-timers, but plan to spend Christmas here? See page 26 for winterizing your home.

2.13 TRASH REMOVAL can be much more expensive in a rural area than in a city. In some cases, your trash dumpster may be several miles from your home. It is illegal to create your own trash dump, even on your own land. In some cases, your only option may be to haul your trash to the landfill.

2.14 RECYCLING Drop-off stations for recycling in Custer County are located east of the Sheriff's Office, 702 Rosita Avenue in Westcliffe, and the landfill, 2250 Rosita Road aka County Road 328. Most plastics can be recycled at Club America, 50 Main Street in Silver Cliff. Check with them for dates and times.

\* Be aware that you are sharing the land with a variety of wildlife. Trash left outside or easily

accessible to nature's neighbors will definitely attract them. Keep trash and pet food in the garage or another secure area, away from hungry animals.

## The Property

There are many issues that can affect your property. It is important to research these items before purchasing land.

- 3.1 Not all lots can be built on. The County Assessor has many parcels that are separate for the purpose of taxation that are not legal lots, in the sense that a zoning permit will not be issued. You must check with the Custer County Planning and Zoning Office to know if a piece of land can be built on.
  - 3.2 Easements may require you to allow construction of roads, power lines, water lines, etc. across your land. Before you dig, contact the Utility Notification Center of Colorado at 811 or (800) 922-1987. Also, there may be easements that are not of record. Check these carefully.
  - 3.3 Many property owners do not own the mineral rights under their property. Owners of mineral rights have the ability to change the surface characteristics in order to extract the minerals. It is very important to know what minerals may be located under the land and who owns them. Much of the rural land in Custer County can be used for mining, however, a special review by the County Commissioners is required.
  - 3.4 You may be provided with a plat of your property, but unless the land has been surveyed and pins placed by a licensed surveyor, you cannot assume that the plat is accurate.
  - 3.5 Fences that separate properties are often misaligned with the property lines. A survey of the land is the only way to confirm the location of your property lines.
  - 3.6 Many subdivisions and planned unit developments have covenants that limit the use of the property. It is important to obtain a copy of the covenants (or confirm that there are none) and be certain that you can live with those rules. (Also, a lack of covenants can cause problems between neighbors.)
  - 3.7 HOAs (Home Owners Associations) or POAs (Property Owners Associations) may take care of common elements, roads, open space, etc. A dysfunctional HOA/POA or poor covenants can cause problems for you or even involve you in expensive litigation.
- \* Custer County does not enforce protective covenants. Visit with your prospective neighbors about their experiences with the covenants.
- 3.8 Dues are almost always a requirement for those areas with a HOA/POA. The bylaws of the HOA/POA will tell you how the organization operates and how the dues are set.
  - 3.9 The surrounding properties will probably not remain as they are indefinitely. You can check with the Planning and Zoning Office to find out how the properties are zoned and to see what future development may be in the planning stages. The view from your property may change.
  - 3.10 If you have a ditch running across your property, the owners probably have the right to come onto your property with heavy equipment to maintain the ditch.
  - 3.11 Water rights that are sold with the property may not give you the right to use the

water from ditches crossing your land without coordinating with a neighbor who also uses the water. Other users may have senior rights to the water that can limit your use or require you to pay for the over sizing or other improvements to the ditch.

3.12 It is important to make sure that any water rights you purchase with the land will provide enough water to maintain the uses you are considering, such as: fruit trees, pastures, gardens or livestock.

? How do I calculate the amount of water my “ideal uses” will consume? The Planning and Zoning Office can estimate water usage for residents and guests. The CSU Extension Office will be able to assist you with averages for livestock, gardens or pastures.

\* The water flowing in irrigation ditches, streams, creeks, springs etc. belongs to someone. You cannot assume that because the water flows across your property, you can use it.

3.13 Flowing water can be a hazard, especially to young children. Before you decide to locate your home near an active ditch, consider the possible danger to your family.

# Mother Nature

Residents in the country usually experience more problems when the elements and earth turn unfriendly. Here are some thoughts for you to consider.

4.1 The physical characteristics of your property can be positive and negative. Trees are wonderful environmental amenities, but can also involve your home in a forest fire. Building at the top of a forested draw should be considered as dangerous as building in a flash flood area. Defensible perimeters may reduce insurance costs, are very helpful in protecting buildings from forest fire and can protect the forest from igniting if your house catches on fire. If you start a forest fire, you are responsible for paying for the cost of extinguishing that fire.

\* Pages 33-40 offer explanations of defensible perimeters and how to protect your property with fire-resistant landscaping. See if your HOA/POA has an emergency plan and escape route(s) for your area. If not, do one for yourself and your guests.

4.2 Steep slopes can slide in unusually wet weather. Large rocks can also roll down steep slopes and present a great danger to people and property.

4.3 Expansive soils and wet soils can create problems such as buckling concrete foundations and twisting steel I-beams. Having a soil test performed will let you know the conditions on your property.

4.4 Even though winters usually don't result in snow staying on the ground more than three or four days, north facing slopes or canyons rarely see direct sunlight in the winter. There is a strong possibility that snow will accumulate and not melt throughout the winter.

\* Again, remember this when planning driveways, garage and home entry doors.

4.5 Snowfalls may be very heavy. For this reason you should consider a 4/12 pitch for your roof as a minimum. At least a 50 pound per foot snow load is recommended for roofs.

4.6 Wind gusts of over 135 miles per hour have occurred, therefore, the Planning and Zoning Office recommends structures be built to withstand hurricane conditions.

4.7 The topography of the land can tell you where the water will go in the case of heavy precipitation. When property owners fill in ravines, they have found that the water that once drained through that ravine now drains through their house.

4.8 A flash flood can occur, especially during the spring and summer months, turning a dry gully into a river. It is wise to take this possibility into consideration when building.

4.9 Spring runoff can cause a very small creek to become a major river. Many residents use sandbags to protect their homes. The County does not provide sandbags, equipment or people to protect private property from flooding.

4.10 Nature can provide you with some wonderful neighbors. Most, such as deer and eagles are positive additions to the environment. However, even "harmless" animals like deer can cross the road unexpectedly, causing traffic accidents and have been known to attack people. Rural development encroaches on the traditional habitat of coyotes, bobcats, bears, mountain lions, skunks, prairie dogs, rattlesnakes, mosquitoes and other animals, reptiles and insects that can be dangerous and/or annoying and you need to know how to deal with them. It is best to enjoy wildlife from a distance and know that if you do not handle your pets and trash properly, it could cause problems for you and the wildlife. The CSU Extension Office, Colorado

Department of Wildlife and the Custer County Planning and Zoning Offices are good resources for information with many free publications to help educate you about living in the wild.

4.11 The elevation of Custer County varies from 5,905 feet to more than 14,000 feet. As the altitude increases, barometric pressure decreases, the air is thinner and less oxygen is available. It's also colder and drier, and the ultraviolet rays from the sun are stronger. Each of these changes may have unpleasant effects on your body.

- \* **ALTITUDE** Much of the Valley is 7,000 to 9,500 feet above sea level, and the mountain summits rise a mile higher. When you first move here, you will probably notice that your breathing is faster or deeper and you may feel short of breath, especially when you exercise. Your heart is likely to beat faster, this is a helpful normal reaction. However, you may also develop a headache, a touch of nausea, or unusual tiredness; some people even have trouble sleeping. These are symptoms of **Acute Mountain Sickness** or AMS. AMS is rarely seen below 6500 feet, but it becomes increasingly common above 8,000 feet. Altitude illness feels very much like flu, or a hangover, and it can be a lot more serious. Symptoms usually go away in a day or two, but if they intensify, consult a doctor. If you develop a worsening cough, increasing shortness of breath or feel like you have fluid in your lungs, **SEE A DOCTOR AT ONCE!** Altitude sickness, though usually minor, can become serious quite rapidly, so don't take it lightly or try to tough it out!
- \* **TEMPERATURE** The sun has more power in the thin air, so no matter how tanned you may be, use a protective cream. Snow blindness (sunburn of the eye) is a real danger, especially on new snow, and even on foggy or cloudy days. Wear sun glasses or goggles with ultraviolet protection. Temperature falls about three degrees Fahrenheit for every 1,000 feet of altitude and it can get cold very fast. Hypothermia (low body temperature) can occur even in the summer if you are wet or wind-chilled, hungry, tired, or poorly dressed. Most people dress appropriately in the winter, but be sure your boots and gloves are not wet or too tight. If you lose sensation in your face, fingers or toes, look for frostbite (numb, cold, white areas) and take time to warm up.
- \* **WATER** The crisp mountain air is exhilarating, but it's also very dry. You lose much more water than you realize in exhaled air and from perspiring. Three or four quarts per day should be considered a minimum. Juices and water are better than tea or coffee or alcohol. At altitude, one alcoholic drink does the work of two.
- \* **SEARCH AND RESCUE** Custer County Search and Rescue is an all volunteer organization on call 24 hours a day, seven days a week, working directly under the Sheriff's Office. Meetings are held at 6:30 p.m. the second Monday of the month at the SAR building, located at 710 Rosita (east of the Sheriff's Office.) The organization is comprised of searchers, a horse team and an ATV team; the snowmobile club helps during winter missions. Some of the money used by SAR comes from donations by homeowners, business owners and landowners. If you are a hiker, please consider buying a **CORSAR** (Colorado Outdoor Recreation Search And Rescue) card. Having this card will enable Search and Rescue to recoup many costs associated with a search. These cards can be purchased locally at Take a Hike, 95 Main Street; the Courtyard Inn, 410 Main Street; or directly from Custer County Search and Rescue. **CORSAR** says be smart and stay alive.

# Agriculture

The people who tamed this wild land brought water to the barren, arid east slope and valley of the Sangre de Cristo Mountains through an ingenious system of water diversion. This water has allowed agriculture to become an important part of our environment. Owning rural land means knowing how to care for it. There are a few things you need to know.

5.1 Agriculture is an important business in Custer County. If you choose to live between the farms and ranches of our rural countryside, do not expect County Government to intervene in the normal day-to-day operations of your agribusiness neighbors. In fact, Colorado and Custer County have “Right to Ranch and Farm” legislation that protects farmers and ranchers from nuisance and liability lawsuits.

\* See page 32 for an excerpt from the Custer County Right to Ranch and Farm Resolution. In addition, ranchers may be spending more and more time dealing with issues related to neighboring development as opposed to running their business including: harassment of livestock by dogs and people, cleaning up trash from trespassers, controlling public access, trespassing and leaving gates open, and maintaining fencing. In many cases, the new neighbors are unaware of their responsibilities since it may be the first time they have lived in a rural area.

5.2 Colorado has an open range law. This means, if you do not want cattle, sheep or other livestock on your property, it is your responsibility to fence them out. It is not the responsibility of the rancher to keep his/her livestock off of your land.

5.3 Farmers and ranchers often work around the clock, especially during planting and harvest time. Dairy operators sometimes milk without stopping, and hay is often swathed or baled at night. It is possible that adjoining agricultural uses can disturb your peace and quiet.

5.4 Land preparation and other operations can cause dust, especially during windy and dry weather.

5.5 Farmers and ranchers occasionally burn their ditches to keep them clean of debris, weeds and other obstruction. This burning creates smoke that you may find objectionable.

5.6 Chemicals (mainly fertilizers and herbicides) are often used in growing crops. You may be sensitive to these substances and many people actually have severe allergic reactions.

5.7 Before buying land, you should know if it has noxious weeds on it that may be expensive to control. You will be responsible for controlling these noxious weeds. The County Extension Office is a good resource for weed management options.

5.8 Animals can be dangerous. Bulls, stallions, rams, boars, etc., can attack human beings. Children need to know that it is not safe to enter pens where animals are kept.

5.9 Much of Custer County receives less than 15 inches (38 cm) of precipitation per year. As a result, we have a problem with overgrazing, and fugitive dust. Without irrigation, grass does not grow very well. There is a limit to the amount of grazing the land can handle. The Colorado University Extension Office, located in the Custer County Courthouse, can help you with these issues.

## **Carbon-Monoxide Detectors**

House Bill 1091 requires installation of carbon-monoxide detectors near bedrooms in new and resold dwellings, as well as rented apartments or homes, as of July 1, 2009.

## **Energy Star Homes**



Tax incentives are available for those building Energy Star Homes.

## **911 Questionnaire Notice**

Attached to this Homeowner's Packet (last page) is a 911 questionnaire for you to fill out and submit to the Sheriff's Office, located at 702 Rosita Avenue in Westcliffe. It is very important that you get the completed questionnaire to the Sheriff's Office as soon as possible. The questionnaire provides information vital to emergency personnel, so give specific information on how to get to your property from Westcliffe. List direction and mileage from the intersection of Hwy 69 and Hwy 96 to the first turn and subsequent direction and mileage (in miles and tenths) of each turn to your driveway and on to the house. Add landmarks such as the stone gates or blue roofed barn, but remember that these might not be seen after dark.

## **In Conclusion**

Even though the County collects property taxes, the amount of tax collected does not cover the cost of the services provided to rural residents.

This information is by no means exhaustive. There are other issues that you may encounter, and we encourage you to be vigilant in exploring and examining those things that could cause your move to be less than you expect.

Again, we have offered these comments in the sincere hope that it can help you enjoy your decision to reside in Custer County. It is not our intent to dissuade you, only inform you.

Adapted from Code of the West and with the permission of John Clarke  
Larimer County, Colorado Commissioner - District 1



# LOCAL SERVICES INFORMATION

(This list is non-inclusive)

## EMERGENCY SERVICE

Sheriff/Ambulance/Search and Rescue ..... 911 or 783-2270  
Wet Mountain Fire Protection District ..... 911 or 783-9245

## HEALTH SERVICES

Custer County Medical Center ..... 783-2380  
Gail Stoltzfus, Public Health Nurse ..... 783-3369  
Luis Marquez, Chiropractor ..... 783-2802  
Byron R. Beard, Dentist ..... 783-9790  
Lighthouse Resource and Pregnancy Center ..... 783-HELP

## VETERANS SERVICE OFFICE

Lorraine Silva ..... 783-9470

## SCHOOL/EDUCATION

Custer County Pre-school ..... 783-4891  
Custer County School K-12 ..... 783-2357  
Custer County School Superintendent and Administration Offices ..... 783-2291  
Magic Moments - Parents As Teachers ..... 783-2112

## CHILD CARE

Robin Gaide ..... 783-9632  
Willene Squire ..... 783-2508

## LIBRARY

West Custer County Library ..... 783-9138  
Wetmore Community Library ..... 784-6669

## POST OFFICE

Westcliffe/Silver Cliff (81252) ..... 783-2453  
Hillside (81232) ..... 783-0800  
Wetmore (81253) ..... 784-3205  
San Isabel area [Rye] (81069) ..... referral 800 275-8777

## DISPOSAL SERVICE

Oak Disposal Services (trash pick-up) ..... 783-3456  
Custer County Landfill ..... 783-2726

### Landfill hours:

Tuesday through Friday 8:00 a.m. - 4:00 p.m.

Saturday\* 8:00 a.m. - 12:00 p.m.

\* Closed Saturdays before a Monday holiday

Landfill will close with sustaining winds over 35 mph or gusts over 50 mph  
and expected to persist for one hour or longer

## UTILITY

Enxx Propane . . . . .	269-1000
Mar Gas Propane . . . . .	888 676-3338
Norup Gas Propane . . . . .	783-9338
San Isabel Services Propane . . . . .	866 427-7432
CenturyLink (land line phone) . . . . .	800 201-4099
Qwest (land line phone) [eastern portion of the county only] . . . . .	800 244-1111
AT&T (cell phone service) [generally the north portion of the county] . . . . .	800 331-0500
Verizon Wireless (cell phone service) [generally the south portion of the county] . . . . .	800 256-4646
Black Hills Energy . . . . .	888 890-5554
San Isabel Electric . . . . .	800 279-7432
Sangre de Cristo Electric . . . . .	800 933-3823

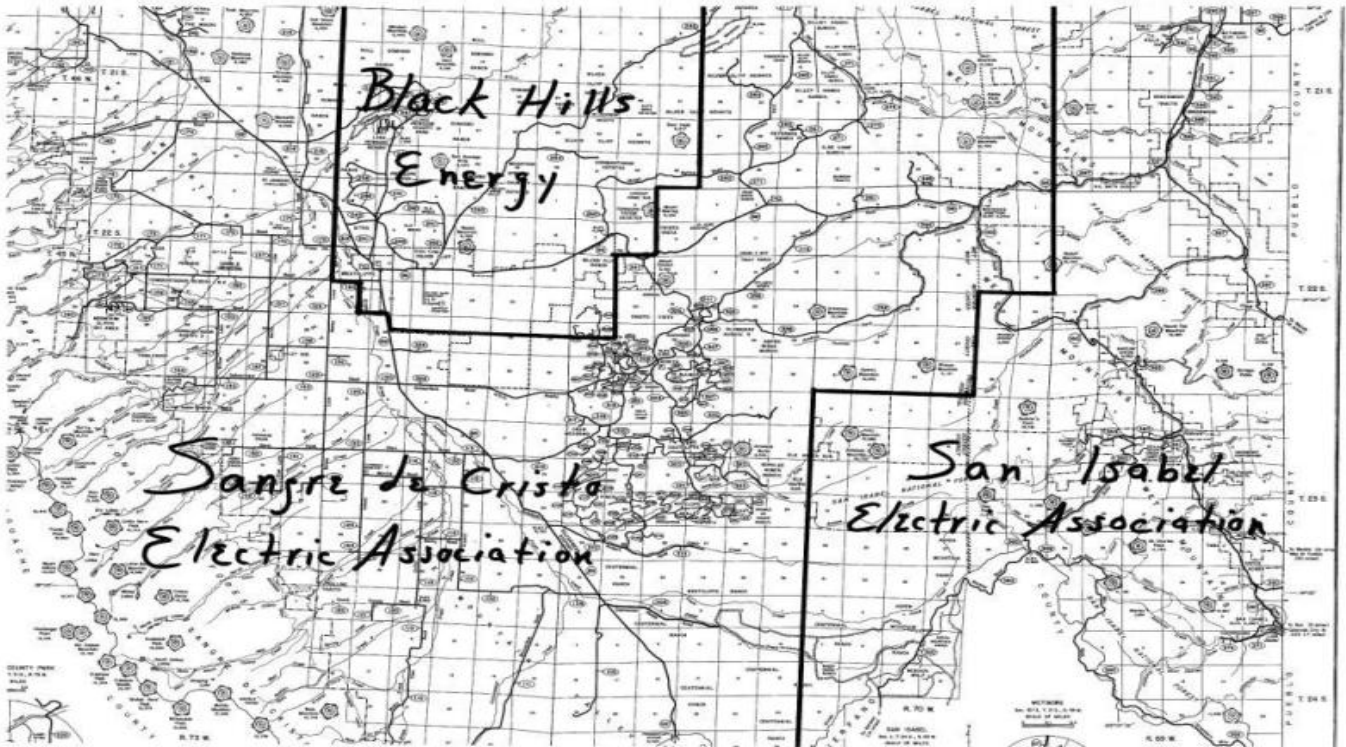

## TRANSPORTATION SERVICE

WMVCSI Public Transit . . . . .	783-2343 or 783-3247
---------------------------------	----------------------

### SENIOR

Senior Center, Lunches, Meals on Wheels . . . . .	783-9508
Vali Assisted Living . . . . .	783-4401
Vista Celesta Apartments . . . . .	783-3228

### VETERINARY

Cliffes Veterinary Clinic . . . . .	783-2032
High Peaks Animal Hospital . . . . .	783-3770
Sangre de Cristo Veterinary Clinic . . . . .	783-2911

**MUSEUMS AND HISTORIC INFO**

All Aboard Westcliffe (Train History) . . . . .	783-0945
Old "Westcliff" Schoolhouse and Museum . . . . .	783-2375
Silver Cliff Museum . . . . .	783-2615
Past Perfect - Historical Research at the West Custer County Library . . . . .	783-9138
Family History Center (LDS) . . . . .	783-2051
Beckwith Ranch House . . . . . (Rene) 371-7076 or (Chamber Office)	783-9163

**CEMETERIES**

Catholic . . . . .	783-3507
Hope . . . . .	783-9773
Rosita (contact Jackie Hobby) . . . . .	783-2433
Silver Cliff (contact Town Hall) . . . . .	783-2615
Ula (contact Pam Holmberg) . . . . .	783-2565

**SILVER CLIFF GOVERNMENT**

Town Hall . . . . .	783-2615
Shop . . . . .	371-7801
Building and Zoning . . . . .	783-3034

**WESTCLIFFE GOVERNMENT**

Town Hall . . . . .	783-2282
Building and Zoning . . . . .	783-9626

**CUSTER COUNTY GOVERNMENT**

Assessor . . . . .	783-2218
Clerk and Recorder . . . . .	783-2441
Combined Court . . . . .	783-2274
Commissioners . . . . .	783-2552
Custer County Resource Center and Annex . . . . .	783-9475
Emergency Manager . . . . .	783-2410
Extension Office . . . . .	783-2514
Human Resources/Finance Manager . . . . .	783-9067
IT/GIS . . . . .	783-2226
Planning and Zoning . . . . .	783-2669
Road and Bridge . . . . .	783-2281
Sheriff's Office . . . . .	783-2270
Social Services . . . . .	783-2371
Treasurer's Office . . . . .	783-2341
Useful Public Service . . . . .	783-9782
Vehicle and Voter Registration . . . . .	783-2441

# Zoning Permit Approval Procedure and Fees

***Important notice: Any structure erected, occupied, moved or structurally altered, without the prior purchase of a zoning permit will bear a penalty of double the cost of the permit in addition to the cost of the permit.***

There can be only one single family dwelling per parcel. On property sized three (3) acres or greater, all structures shall be located at least fifty (50) feet from any property line or roadway easement boundary and at least sixty (60) feet away from the edge of the driven surface of a roadway, where a recorded roadway easement does not exist. On property less than three (3) acres, but greater than a half (½) acre, all structures shall be located at least twenty-five (25) feet from all property lines or boundaries. On property one-half (½) acre or less, all structures shall be located at least ten (10) feet from all surveyed property lines or boundaries.

\* See page 19 for how to measure building height.

Zoning permits will be valid for a period of two (2) years for the completion of the exterior. If the exterior construction has not been completed in that time period, a new permit must be applied for.

Fees are based on the category of structure and total floor area. These categories are: Dwelling, Accessory Building Enclosed , Accessory Building Open on at Least One Side, Deck added after original permit is closed. No Zoning permit is required for an accessory structure or deck 100 square feet or less, but these must still meet setbacks.

Zoning permits for a **Dwelling will not be issued** without a permit for sewage disposal (25-10-111, C.R.S. 1973), in compliance with the Custer County On-site Water Treatment System (OWTS) Regulations.

Procedure:

1. Complete a Zoning Permit Application. Submit the application, plot plan, floor plan, elevation drawing and appropriate fee to the Planning and Zoning Office.
2. Approval of a permit will be granted when the above conditions are met and verified and the following requirements are complied with:
  - A. A completed septic permit application has been accepted.
  - B. The applicant establishes a legally adequate and physically available water source.
  - C. The applicant demonstrates that the proposed structure will comply with applicable provisions of the Custer County Zoning Resolution.
3. Before an open permit can be closed:
  - A. The structure must be dried in
  - A. Proof must be provided that an electrical inspection has been completed (if required.)
  - B. Proof must be provided that a plumbing inspection has been completed (if required.)
  - C. County use tax obligations have been met.
  - D. Compliance inspection of the site confirms that the structure, On-site Water Treatment System (if required, must be installed before occupancy), water, and other zoning commitments are in compliance with the Custer County Zoning Resolution.

## Custer County Use Tax Instructions

County Use Tax on **building material** is due if you purchased materials without paying local sales tax. Usually, these would be on material purchased outside the county and delivered to property located within the county.

**Building material** is defined as any material used in the construction of a structure to include: built-in appliances, fixtures, floor coverings, as well as any obvious or standard construction materials.

Copies of receipts must be available to the Planning and Zoning Office, when requested, to verify whether local tax was paid at the time of purchase. The permit will not be closed until this is taken care of.

Depending on the circumstances, one of the following three deadlines will apply to your payment of County Use Tax:

1. If the total tax due will be less than three hundred dollars (\$300.00) during one calendar year, the tax must be paid by January 20<sup>th</sup> of the following year; or
2. If you anticipate owing more than three hundred dollars (\$300.00) in tax, you may submit \$300.00 with the application and pay the remainder at the end of the project. Use Tax payment is non-refundable.
3. Use tax must be paid before the permit will be closed.

# Custer County Planning and Zoning Fee Schedule

Adopted by County Commissioners and effective February 6, 2015 (These fees are non-refundable)

<b>Zoning Permits:</b>	<b>Pre-const.*</b>	<b>Post-const.*</b>
Residential intended for habitation (Including Factory Built Dwellings)	\$0.35/sq.ft.	\$1.05/sq.ft.
Accessory Buildings-Enclosed	\$0.35/sq.ft.	\$1.05/sq.ft.
Accessory Buildings-Open on at least one side	\$0.25/sq.ft.	\$0.75/sq.ft.
Decks/balconies greater than 100 sq.ft., if not part of original structure	\$25.00	

**County Road & Bridge Driveway Access Permits:** \$75.00

**A permit will not be required for any accessory building of 100 square feet or less.**

\* Per Zoning Resolution Section 8.1 which establishes Zoning Permit requirements.

**Septic Permits:**

New Installation of Standard or Engineered System	\$225.00
New Installation of Vault System or Vault Privy (needs BOCC variance)	\$225.00
Modification of Septic System	\$125.00
Repair of Septic System	\$50.00
Contractor licensing	\$50.00 + \$10.00 subsequent years
Copy of Septic Regulations (free online at CusterCountyGov.com)	\$14.25

These fees include inspections for standard systems, vault variances, etc., and as required for engineer-designed systems. A \$75.00 per trip will be charged if additional inspections are needed because the system is not ready at the scheduled time or the system fails inspection.

Copy of Zoning Resolution (free online at CusterCountyGov.com)	\$7.50
Xerox Copies Black and white	\$0.25 per page
Xerox Copies Color	\$1.00 per page

**Sign Variances:**

\$200.00

**Home Occupation:**

\$25.00

**Zoning Issues:**

	Administrative	Board Action
Lot Line Vacation	\$50.00	\$300.00
Lot Line Adjustment		\$300.00
Zoning Change		\$300.00
Over height		\$300.00
Setback		\$300.00
Multi-dwelling		\$300.00
Senate Bill 35 Waiver/Creation of Undersize Lot	\$50.00	\$300.00
Vested Rights		\$300.00
Special Events Permit	\$50.00	\$300.00

(If three (3) or more events are scheduled at one time, the first is \$50.00 and \$10.00 for all others)

If an applicant applies for more than one variance at a time, only the highest fee will be charged.

**Special Use Permit (SUP/ Planned Unit Development (PUD) / Subdivision:**

SUP		\$300.00 for Presentation \$200.00 for hearing
SUP Modification		\$150.00 + additional fees for professional services and postage, if required
PUD/Subdivision	Sketch Plan	\$250.00 + additional fees for professional services and postage, if required
	Preliminary Plan	\$600.00 + additional fees for professional services and postage, if required
	Final Plan	\$600.00 + additional fees for professional services and postage, if required
	Modification	\$300.00 + additional fees for professional services and postage, if required

Prior to recording of final plat, the applicant shall deposit with the County Commissioners, one thousand dollars (\$1000.00) per dwelling or commercial unit. The fee is to be divided as follows: Twenty percent (20%) to County General Fund, Thirty percent (30%) to County Capital Improvement Fund, Twenty percent (20%) for the Road and Bridge Department, Ten percent (10%) for the Sheriff's Department, Ten percent (10%) to the C-1 School District, and Ten percent (10%) to Emergency Services.

**County Subdivision Road Access Permit:** \$200.00

**Applicants may be required to pay additional postage if postage exceeds 20% of the application fee.**

**Misrepresentation on an application will cause a permit to be cancelled and will require a new application and fee.**

## Example of a Plot Plan

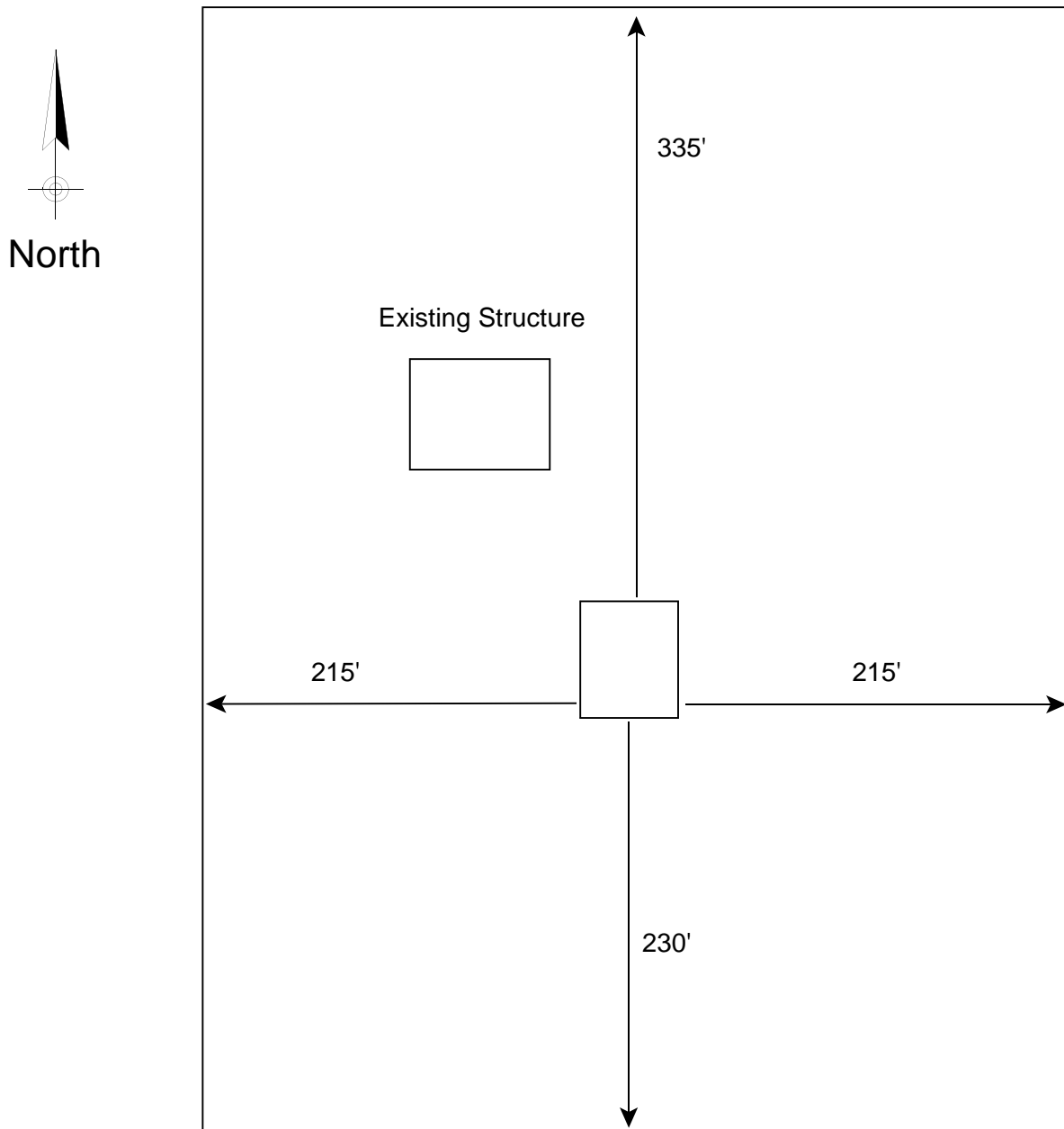

John and Mary Homesteader  
Heavenly Acres 1, Lot 1

(Setbacks are fifty feet (50') for properties of three acres or more. Twenty-five feet (25') for less than three acres but more than one-half acre and ten feet (10') for properties one-half acre or less with survey.)

# Building Height Regulation

Building Height Maximum: The vertical distance from the highest point of the finished grade of the building perimeter to the high point of the building structure must not exceed thirty (30) feet. Backfill to provide drainage or blending into existing grade for landscaping is important for construction finish. However, backfill applied to the building perimeter for the purpose of circumventing the finished building's heights requirement will be considered a violation of the Resolution.

## Example of an Elevation Drawing

Maximum Height = 30 feet From finished grade

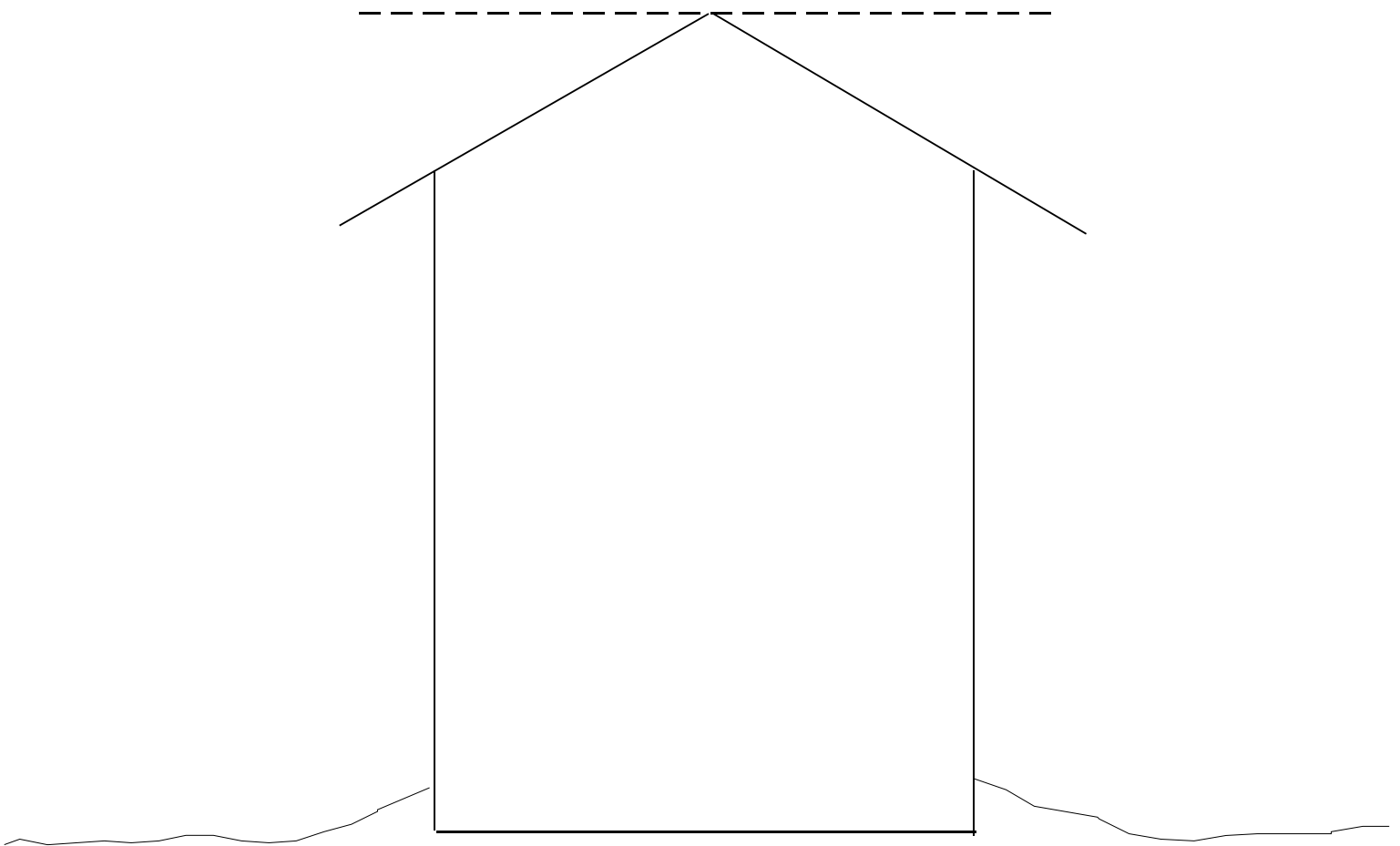

John and Mary Homesteader  
Heavenly Acres 1, Lot 1

There cannot be any excavation on or around the building site until the permit is processed.

## Factory Built Home and RV Ordinance

Factory Built Homes will be allowed in Custer County under the following conditions: a factory built home must have the wheels removed (if applicable) and be blocked and leveled with skirting applied around the base, and/or be placed on a permanent foundation. No factory built home may be transported until a zoning permit is obtained from the Planning and Zoning Office. Any factory built home constructed prior to 1977 will not be eligible for a permit. (Model year 1977 began in mid-summer 1976. This information is provided on the data plate. If there is no data plate, it can be assumed the home was built before 1977, unless other evidence is discovered. The data plate will be located on or near the electrical service panel or on the back of a kitchen cabinet or closet door.)

\* Some protective covenants do not allow factory built homes. Check with the HOA/POA. In a dispute with the above ordinance, the association would win. The more restrictive ruling applies.

Any Recreational Vehicle (RV) or self-contained travel trailer that will be regularly occupied on private property as a primary residence, other than a RV campground, for longer than ninety (90) consecutive days will be considered a permanent dwelling. As such, they will be subject to the same Zoning and Septic regulations as any permanent dwelling, i.e. Zoning Permits, Septic Permits, and Variances for non-conformance must be obtained. **Note: It is illegal to occupy a property, even on an occasional basis, without an approved septic system or a variance to the On-site Water Treatment System (OWTS) according to State (Colorado Revised Statute 25-10-112 (6)) and County Codes (Custer County Septic Regulations, I.B General Sanitation Requirement).**

Recreational Vehicles stored on the owner's land (i.e. the vehicle is unoccupied) shall maintain current license and registration. The Planning and Zoning Office may require proof that the vehicle is being stored. These recreational vehicles are exempt from the ninety (90) day limitation.

\* Check your HOA/POA protective covenants to see if RVs are allowed to be stored outside for lengthy periods. Some HOA/POAs require RVs to be shielded from view.

## Transporting and Selling of Mobile Homes

The owner of a mobile home has the responsibility for notifying both the County Assessor and the County Treasurer before moving mobile homes. A moving permit and tax authentication must be obtained from the Treasurer's Office up to 30 days prior to moving the mobile home. The County Treasurer will prorate the value of the mobile home for the amount of time the mobile home will be in the County.

If the owner does not notify the County Assessor and Treasurer that the mobile home will be moved and does not prepay taxes the owner will be fined \$50.00 once the new location is discovered, according to State Statute (C.R.S. 1973, 42-6-132 (2) (b)). The fine for the movement of a mobile home without either a permit or a prorated tax receipt is \$200.00.

The seller is responsible for making sure that all property taxes have been paid on the mobile home. When a title is submitted to the Department of Motor Vehicles for recording a new owner's name, by law it must be accompanied by a "Tax Authentication" issued by the County Treasurer. This certificate indicates whether or not any property taxes are currently due on the mobile home. The seller must provide the buyer with a "Certificate of Title" to facilitate the transfer of the title. The seller, by law, must also provide a listing of the household furnishings included in the sale price.

The buyer must apply for a new title from the Custer County Clerk and Recorder's Office within forty-five (45) days of the sale date.

Prior to locating a mobile home on a parcel of land, a permit must be obtained from the Custer County Planning and Zoning Office. After the review of the OWTS plan and approval from the Zoning Office, the permit is issued.



# Septic Permit Approval Procedure

***Important Notice: All systems MUST be inspected by the County OWTS Health Officer or representative BEFORE the system is backfilled. Failure to do so will require that the system be uncovered for inspection.***

Septic permits will be valid for a period of one (1) year or until permit is closed by the Planning and Zoning Office. If the installation, modification or repair has not been completed in within that time period, a new permit must be applied for and granted. (Chapter 25, Article 10 C.R.S., 1973).

A zoning permit for a dwelling will not be issued without a plan for sewage disposal (25-10-111 C.R.S. 1973) in compliance with Custer County On-site Water Treatment System Regulations.

Procedure:

1. Complete septic permit application. Submit application, soil percolation test report, and fee to the Custer County Planning and Zoning Office.
2. Approval of a permit will be granted when:
  - A. All permit fee obligations are met.
  - B. A soil percolation (perc) test report from a qualified Geologist, Engineer or Custer County authorized technician has been submitted.
  - C. The perc test shows that a standard system can be installed, or a qualified Engineered design has been submitted.
  - D. Use tax payment has been arranged for, or paid.
3. Finalization of an open permit will be granted when:
  - A. Use tax obligations have been met.
  - B. The system has been inspected and passed by the County OWTS Health Officer, if a standard system
  - C. If an Engineer designed system, the system has been inspected by the Engineer who certifies it is installed according to his design.

Restrictions:

1. A septic system will **NOT** be installed on a lot less than one acre in size, unless the system is designed by a Professional Engineer, licenced by the State of Colorado, and the design is approved by the Board of County Commissioners or their authorized representative.
2. Any On-site Water Treatment System other than a septic tank and leachfield must be approved by the Board of County Commissioners or their authorized representative before the system is installed. A variance may be required.
  - \* Plan ahead. The two above restrictions can take more than a month.
3. The system must be installed by a contractor licensed by Custer County to install septic systems.
4. All components of the system, and measured distances, must be accurate on the plan presented with the permit application or on the Engineered design.
5. For Engineer designed systems, an original copy of the design, with the Engineer's stamp, must be submitted.

# CONTRACTORS LICENSED TO INSTALL SEPTIC SYSTEMS IN CUSTER COUNTY

**This listing is NOT intended to recommend a contractor. To be licensed, a contractor pays a fee and passes a test.**

All area codes are (719) unless otherwise noted

Brad Baltzly  
Baltzly Construction Services, LLC  
505 Sandia Circle  
Westcliffe, CO 81252  
783-2948

Douglas Bayer  
Bayer Enterprises  
1094 County Road 260  
Westcliffe, CO 81252  
783-2916

Robert Buffum  
P. O. Box 561  
Westcliffe, CO 81252  
371-0406

Roger Camper  
Ula Builders  
776 County Road 175  
Westcliffe, CO 81252  
783-9441

Bill Canda  
Talon Earthworks  
4499 County Road 130  
Westcliffe, CO 81252  
783-2500

Matthew Clark  
Clark Construction  
1019 W. Montebello Drive  
Pueblo West, CO 81007  
491-6514

Jason Coleman  
P. O. Box 1247  
Westcliffe, CO 81252  
371-6549

Vernon Collins  
Collins Construction  
P. O. Box 162  
Silver Cliff, CO 81252  
276-4493

Shane Cooper  
Dirt Guys, LLC  
949 Shannon Road  
Cotopaxi, CO 81223  
276-3234

Larry Finney  
Finney Excavating  
815 Meadows Avenue  
Cañon City, CO 81212  
275-9525

Russell A. Gillespie  
R & R Construction  
P. O. Box 85  
Coaldale, CO 81222  
942-3694

Gary Gillis  
Gillis Excavating  
1055 Valley View Drive  
Cañon City, CO 81212  
275-0469

Cliff Hobby  
C. T. Hobby Road Construction  
110 County Road 329  
Westcliffe, CO 81252  
783-2433

Thomas Holgerson  
T. K. Construction of Rye  
P. O. Box 268  
Rye, CO 81069  
489-2311

Ken Houston  
6635 County Road 28  
Cotopaxi, CO 81223  
942-3198

Mike Hoxie  
H & H Concrete & Builders  
1430 15<sup>th</sup> Street  
Penrose, CO 81240  
372-3988

Trinity Huffman  
P. O. Box 1405  
Westcliffe, CO 81252  
783-0300

Thomas Joseph  
Colorado Backhoe Service  
25193 South Road  
Pueblo, CO 81006  
924-0288

Andrew Kagan  
Kagan and Sons, LLC  
555 Ernest Avenue  
Westcliffe, CO 81252  
783-9636

Patrick Kerns  
Lil' Eagle Components  
6130 County Road 328  
Westcliffe, CO 81252  
783-2886

Paul King  
Mesa Excavating  
113 Latigo Lane, Suite D-130  
Cañon City, CO 81212  
269-2520

Bennie Koch  
Rocky Mountain Excavating  
2976 L Path  
Cotopaxi, CO 81223  
942-4311

Michael Langson  
Langston Concrete, Inc.  
12998 County Road 255  
Westcliffe, CO 81252  
546-3000

George Largent  
H&B Rebar  
729 Navajo Drive  
Cañon City, CO 81212  
7839742

Donald Lipka  
Big D Plumbing, LLC  
880 Adobe Creek  
Florence, CO 81226  
240-1559

Anthony Lippis  
Ray Lippis Excavating  
910 Riverside  
Cañon City, CO 81212  
275-6170

Ed Lyons  
Mountain Valley Excavating  
P. O. Box 875  
Westcliffe, CO 81252  
783-3535

Thad Miller  
Miller Excavation  
0163 7th Trail  
Texas Creek, CO 80223  
221-2299

Enos Mullett  
Mullett's Western Buildings  
P. O. Box 594  
Westcliffe, CO 81252  
783-2542

Myron Mullett  
Mullett's Excavating  
P. O. Box 322  
Westcliffe, CO 81252  
783-2056

David Nequette  
Nequette Drilling and Excavating

P. O. Box 186  
Westcliffe, CO 81252  
783-3000

Chris Nordyke  
Construction Solutions of Colorado  
57680 Hwy 69  
Westcliffe, CO 81252  
371-1395

Gregory Pagnotta  
Pagnotta Excavating  
P. O. Box 635  
Rye, CO 81069  
489-3444

Larry Pieper  
Pieper Construction  
P.O. Box 25  
Rye, CO 81069  
485-3841

Gregory Quade  
Lookout Mountain Excavating  
1798 Pronghorn Path  
Cotopaxi, CO 81223  
371-4742

Anthony Scalese  
T & S Excavating  
27490 South Road  
Pueblo, CO 81006  
545-4243

Steven Stanley  
246 Marcey Road  
Westcliffe, CO 81252  
783-2083

Daryl Thompson  
Colorado Mountain Home Builders  
17199 Buffalo Valley Path  
Monument, CO 80132  
659-6251

John Vallejos  
Butte Valley Construction  
P. O. Box 146  
Walsenburg, CO 81089  
738-3963

Fred White  
White's Excavation  
P. O. Box 754  
Westcliffe, CO 81252  
783-4442

Gary V. Wilson  
Wilson Excavation Inc  
531 8th Street  
Penrose, CO 81240  
372-6868

**Perc Technicians**

Kit Shy  
Shy Surveyors  
P. O. Box 1280  
590 Hermit  
Westcliffe, CO 81252  
783-2347

Rock Canda  
Coldwell Bankers  
509 Main Street  
Westcliffe, CO 81252  
783-9131

**Septic Pumpers**

Arthur Nordyke  
57798 Hwy 69 South  
Westcliffe, CO 81252  
783-2747

Kenagy Septic Services  
827 Pine Avenue  
Canon City, CO 81212  
275-0644

Mountain High Septic  
P. O. Box 427  
Salida, CO 81201  
530-1601

Pat Steel  
Rye Septic Service  
8245 Park Road  
Rye, CO 81069  
489-2416

**Water Commissioner**

Jerry Livengood  
1661 County Road 170  
Westcliffe, CO 81252  
429-1863

This list was updated November 2014

# Septic System Operation and Maintenance

The primary function of the septic tank is to settle out solids from the wastewater. Solids settle out by holding the sewage in a quiet environment within the tank. But as solids build up, there is less room in the tank for the liquid and thus less settling time. The accepted maximum level of solids in the tank is 1/3 of the liquid depth. Any more than this and the tank is overdue for pumping. Having these solids removed is a critical component of how well the septic system will function as a whole.

Keep toxic and hazardous chemicals out of the septic system. They may harm the bacteria that are essential for the “health” of your system. Over use of household bleach, cleaners and detergents will harm the bacteria in your system, the bacteria will take time to recover and the system will not operate correctly until then. Follow the label instructions on the container. Moderate volumes of chlorine bleach will be assimilated in the septic tank. Phosphate detergents normally do not harm either the septic system or groundwater. Use sparingly.

Watch what you put down the drain. Do not dispose of coffee grounds, eggshells, cooking oils, paper towels, sanitary napkins or tampons, disposable diapers, cat litter, plastics or cigarette butts in the septic system. They fill the tank rapidly, decreasing its efficiency and increasing the need for pumping. Choose toilet paper labeled “safe for septic systems.”

## **Some alternative household cleaning solutions that won't harm septic systems**

Baking Soda for cleaner, deodorizer, fire extinguisher, scouring powder

Clean drains by pouring in 1/4 cup baking soda followed by 1/2 cup vinegar

Salt for cleaner

Soap for cleaner (not anti-bacterial)

Lemon for cleaner, deodorizer, stain remover

White vinegar for cleaner, deodorizer, grease cutter

Borax\* for cleaner, disinfectant, laundry aid, water softener

Washing soda\* for cleaner, laundry aid, grease cutter, stain remover, water softener, disinfectant

\* These products are not completely non-poisonous but are less toxic than their ready-made counterparts.

To help protect your system from freezing, plant a grass cover over the components of the system. If the system is installed too late to grow a dense grass cover, then loose hay or straw should be placed over the system. Wind may blow the cover away unless it is held down by laths, plastic mesh, or other means. Do not plant vegetable gardens over the leachfield. The tank can also be covered with at least two inches of expanded polystyrene of a type suitable for burial. This will provide as much insulation as about 4 feet of dry soil cover. Keep trees and bushes away from leachfield. Do not let large animals pasture on the leachfield as they may compact the soil.

Don't dispose of water from hot tubs in the system. The large volume of water will overload the septic tank and leachfield and the chlorine will kill the bacteria necessary for the decomposition of solids. Excessive water use is one of the main causes of septic system failure.

Reduce household water usage by:

- Using water-saving bathroom and kitchen fixtures (faucets, shower heads, toilets)
- Run appliances such as dishwashers and washing machines at different times
- Spread laundry over an entire week
- Fix all faucet and toilet leaks promptly
- Direct water from downspouts and roofs away from the leachfield
- Do not run water to prevent water pipes from freezing, use pipe insulation or heat tape

Avoid excessive use of the garbage disposal, even when the system is sized for one, because it greatly increases the amount of solids entering the septic tank. This reduces the liquid capacity of the tank and accelerates the need for pumping. If the outside, temporary storage of food waste, or use of a compost pile will attract wild animals, like bears, mountain lions, raccoons, coyotes, feral cats, skunks, and others, then the use of a garbage disposal will dispose of the food waste where animals will not be attracted to them. Because of the increase in organic loading to the septic tank and the leachfield, if attraction of wild animals is not an issue, use of a garbage disposal should be avoided.

Keep the septic tank as warm as possible by using warm water to wash clothes in the winter. Flush the toilet after every use so there is no trickle flow into the system. As we often have cold winter temperatures with no snow, have your septic contractor install insulated pipe from the house to the tank. Don't drive over or build anything over the leachfield. This will compact the soil and may break the chambers. Never flood-irrigate the field as this will saturate it and may cause it to fail.

The tank should be inspected each year to determine sludge depth. Tanks usually need pumping every 2 to 5 years, depending on tank size and use. See table below.

Keep a record of sludge depths as well as of the dates when the tank was pumped. When the septic permit is finalized, the Planning and Zoning Office will send information on your contractor, the type of system, a sketch of the system layout and a pamphlet from Infiltrator® Systems, Inc. The pamphlet also has space provided for you to keep a record of maintenance.

Remember, the main causes of septic system failure are:

- Infrequent septic tank pumping
- Placing items that do not decompose into the system
- Use of anti-bacterial hand and body soaps, cleaners, detergents
- Overuse of water
- Overuse of garbage disposals
- Damage from excavation or from vehicles driving over the system

Approximate number of years between septic tank pumping for a year-round residence without a garbage disposal.

		Number of people in household							
		1	2	3	4	5	6	7	8
Tank size in gallons	1000	12	6	3.5	2.5				
	1200	15	7.5	4.5	3.5	2.5	2		
	1500	19	9	6	4	3	2.5	2	1.5
	1750	22	10	7	5	4	3	2.5	2
	2000	25	12	8	6	4.5	3.5	3	2.5

**Note: If a garbage disposal is used, pumping should be done twice as often.**

## Winterizing Plumbing

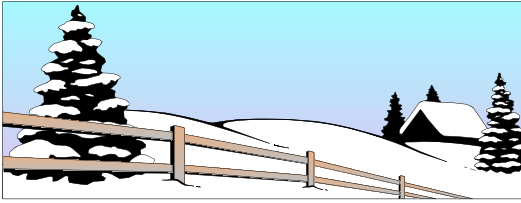

Use nontoxic antifreeze when winterizing cabin or household plumbing. The RV industry has an antifreeze that can be used in the water piping system of a recreational vehicle. This protects the pipes against freezing in the case of possible low spots that will not drain out. The pipes in a RV are in the walls and floor and it is often difficult to be sure that they all drain properly. To protect against freezing, the water supply system should be filled with the RV antifreeze. The RV antifreeze is apparently biodegradable and is not toxic. This type of antifreeze can also be used to fill the water pipes of a home or cabin system.

In a house or cabin, however, we suggest draining all the pipes and making sure that the piping system does not have any low spots. In addition, the pipes can be blown with high pressure air to be sure that no water remains anywhere in the pipes. It might be advisable to have a plumber help set up and check the water piping system to be sure it is drained. Don't forget to drain the water pump, the water heater and the dishwasher.

Make sure that none of the traps are open in the septic system. Liquid filled traps prevent gases from the septic tank entering the structure. If the trap is full of a nonfreezing solution of nontoxic antifreeze, no gases from the septic tank can get into the structure. It is also possible to remove the traps under sinks and plug the pipe that leads into the waste water system. This is more work but it is effective to prevent freezing and to prevent any gases from getting into the house.

If you drain the toilet bowl, be sure that it does not have a double wall in the bottom under which some liquid remains. If there is some water in that location, it will freeze and crack the toilet bowl. If you are not sure about the toilet bowl construction, the safest approach may be to drain the toilet flush tank and then pour nontoxic antifreeze into the toilet bowl.

So, to winterize your structure, drain all the water pipes and all water using appliances. Add a nontoxic antifreeze to the plumbing traps and the toilet bowl to protect against freezing and to prevent septic tank gases from entering the house.

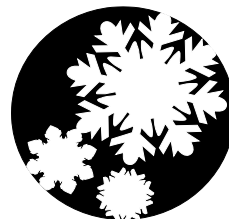

## **Cistern / Water Storage**

Installing a cistern on your property is advantageous for several reasons. If your well produces only a few gallons per minute, pumping into a cistern will insure that you will have water when you need it. If your cistern is up hill from your house, the water can be gravity fed into the house or pumped more easily into the pressure tank. A cistern will aid the Fire Department in putting out a fire, which may be looked at favorably by your home insurance company. The following is from the Wet Mountain Fire Protection district.

### **Wet Mountain Fire Protection District Cistern Specifications**

The following are recommendations set by the Wet Mountain Fire Protection District for installing water cisterns on private and commercial property. These are so the Fire District can easily access the cistern for water to fight a fire.

1. Install the cistern a minimum of 150 feet from closest point of structure to be protected.
2. Clear 50 feet around the cistern for access.
3. Install the cistern a maximum of 300 feet from structure to be protected with access.
4. To install in circular drive - place in center of drive if 150 feet from structure to be protected.
5. Be sure to register your cistern by updating your 911 survey. The 911 survey is included at the end of this packet.

Please see diagrams on the next two pages for piping, fittings and depth. Using these guidelines will ensure the Fire District access to your cistern in an emergency situation.

# Wet Mountain Fire Protection District Cistern Specifications

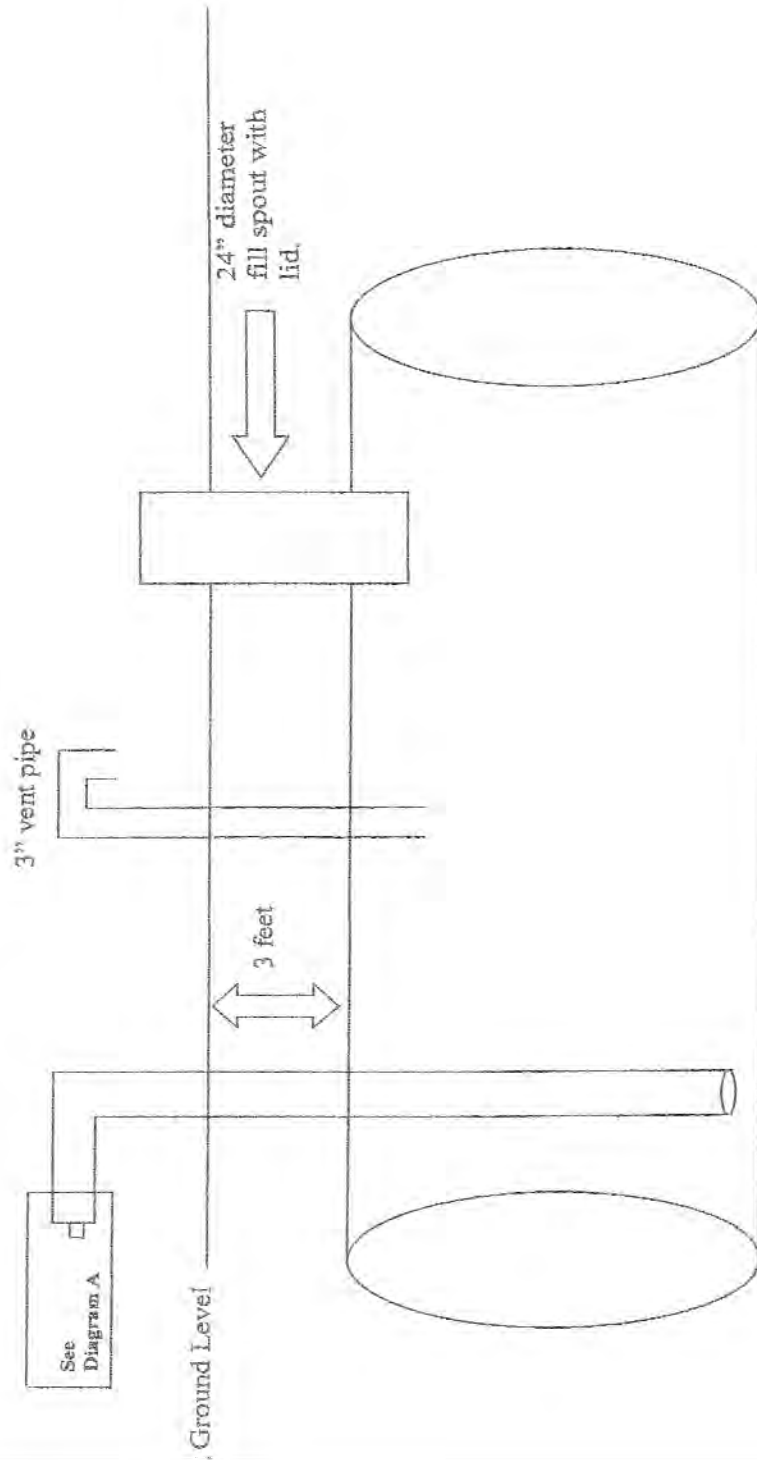

Drawn by: B.L.L.  
2001



**Diagram A** *Small Cisterns 1000 to 5000 gallons*

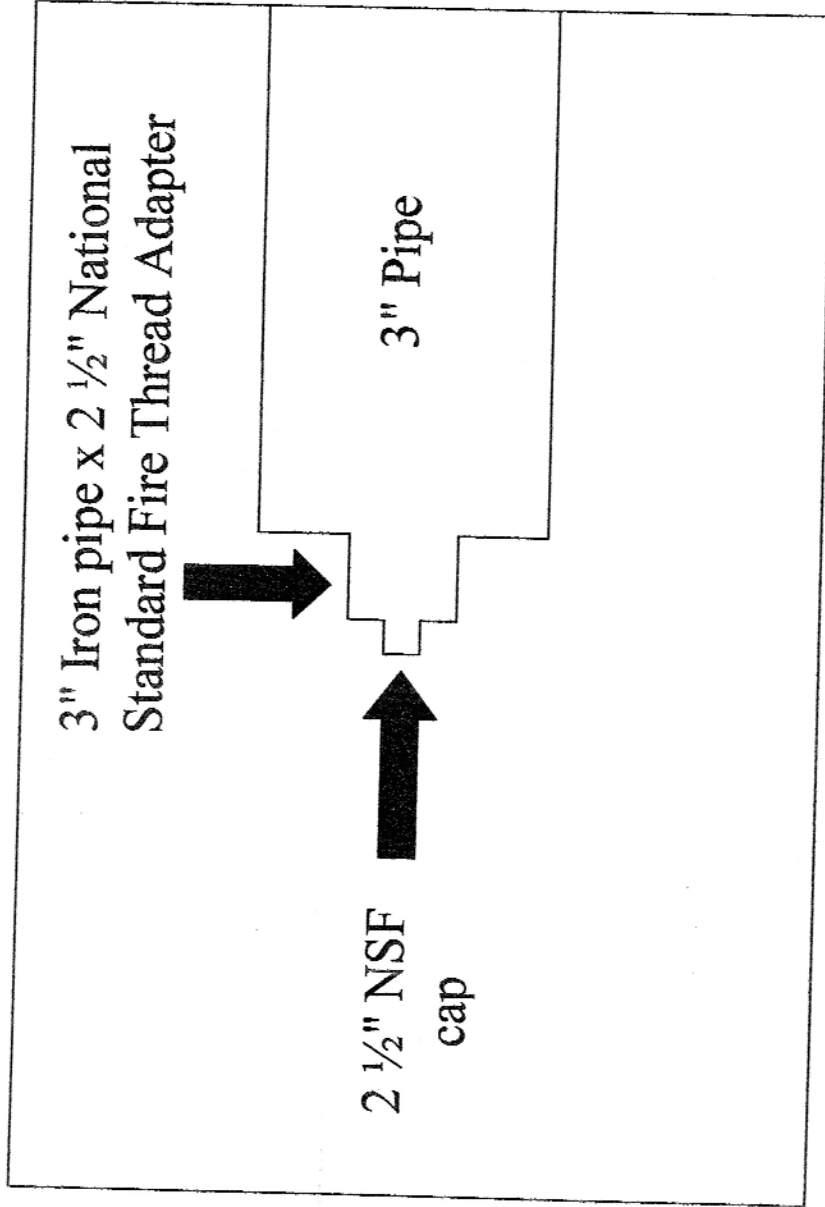

3" horizontal pipe run shall not exceed 3-4 feet in length, and be 3 feet above finished ground level.

2" vent pipe with 180° bend shall be 3 feet above finished ground level.

# Road and Bridge Specifications for Driveway Installation

Property owners are reminded that construction of access ways from County roads requires a permit which can be obtained at the Custer County Road and Bridge Shop. This is necessary to assure that safety standards for access to public roads are met and to insure that adequate provisions for surface water drainage is provided.

Ingress and egress from County roads must be approved by the Road and Bridge Department before installation, and the expense of the installation shall be borne by the property owner. Provision must be made for the disposal of drainage waters and an annular culvert at least fifteen (15) inches in diameter shall be required across the access way. Driveway culverts will be a minimum of twenty feet (20') long. Inlet and outlet pipe will be riprapped or concreted to prevent erosion. A plat plan of any development will be provided to the Road and Bridge Supervisor before any access way is approved. A maximum of one access is allowed per residence. A copy of the final acceptance and approval will be given to the property owner.

## Mailbox Installation Along Publicly Maintained Rights-of-Way

- A. Customers must use only approved traditional or contemporary mailboxes. Custom-built mailboxes may be used if the local postmaster gives prior approval and the mailbox conforms generally to the same requirements as approved manufactured mailboxes.
- B. Mailbox supports should be a semi-arch or extended arm type which allows snow plows to sweep near or under mailboxes without damaging supports and provides easy access to the mailboxes by carriers and customers.
- C. Mailbox supports should be no larger than a 4"x4" wood post or a 2" diameter standard steel or aluminum pipe, buried no more than 24 inches. If struck, this type of post should safely break away without causing damage or injury.
- D. Mailboxes should be installed with the bottom of the mailbox at a vertical height of 48" from the road surface.
- E. On Custer County maintained roads, mailboxes should be installed so that the face of the mailbox is even with the shoulder of the road.
- F. On Colorado State highways, mailboxes must be placed a minimum of 8 feet from the edge of the highway, with the approach to the mailbox properly filled and graded.
- G. Mailboxes must be on the right-hand side of the road in the carrier's direction of travel. The approach to the mailbox should be clear of snow, vehicles and other obstructions.
- H. House number and street name must be on the mailbox, visible to the approaching carrier. Letters and numbers must be 1" or more in height.

## Important Notice Regarding Private Roads

Subdivisions in Custer County may have private roads. Colorado law permits this and exempts private roads from any County regulation. This means that the roads may be built in such a way that they do not comply with County specifications, and may never be eligible for County maintenance. Without county maintenance it is often not possible to provide school bus transportation, fire protection, law enforcement support and emergency medical help. These matters are of sufficient importance that we feel justified in calling them to your attention before you build a dwelling. Please consider them carefully before you proceed.

# State Plumbing and Electrical Permit Information

Custer County construction is covered by the State of Colorado Electrical and Plumbing Codes. New construction that will have plumbing or electricity requires a State permit before construction begins. Plumbing includes both water and propane. The State Inspectors work out of the Cañon City Office. Questions about methods of construction, permit applications and fees, and inspection requirements should be directed to that office. Permits can be obtained on-line.

State Plumbing Inspector:  
Stephen Kirkwood  
(855) 451-9791 Toll Free  
Stephen.Kirkwood@state.co.us  
[www.dora.state.co.us/plumbing](http://www.dora.state.co.us/plumbing)

State Electrical Inspector:  
John Figa  
(877) 305-7541 Toll Free  
John.Figa@state.co.us  
[www.dora.state.co.us/electrical](http://www.dora.state.co.us/electrical)

## Compliance Inspection

A compliance inspection must be arranged for when the following are met:

- A. The structure is dried in,
- B. The appropriate plumbing inspection has been completed, if applicable,
- C. The appropriate electrical inspection has been completed, if applicable,
- D. The On-site Water Treatment System has been installed and has passed inspection, if applicable and,
- E. The use tax obligation has been met.

Call the Zoning Office at (719) 783-2669 to make an appointment for the inspection.

### Procedure

1. The applicant will call for a compliance inspection after the above criteria are met.
2. The Planning and Zoning Office will schedule the compliance inspection.
3. The inspection will be performed using the following standards:
  - a Height: Custer County Zoning Resolution. The height will be measured in two places: 1) from the high point of grade, at the building perimeter, to the high point of the building structure, which must not exceed twenty-five (25) feet, and 2) the height from the low point of grade at the building perimeter to the high point of the building structure, which must not exceed thirty-five (35) feet. Grade at the building perimeter is either natural or finished whichever is lower in elevation.
  - b Septic: Custer County Septic Regulations. The number of bedrooms and appliances will be confirmed to verify sizing of the leach field and septic tank.
  - c Setback: Custer County Zoning Resolution. Setback compliance will be confirmed on all sides of the structure. If the setback distance is substantially over the current setback requirements, an estimate may be substituted.
  - d Square footage: Custer County Zoning Application. The outside dimensions of the structure will be measured to the nearest whole foot and compared to the square footage of the structure on the application.
  - e Single-family dwelling: Custer County Zoning Resolution. Custer County allows only one single-family dwelling per parcel of land unless a multi-dwelling variance has been granted or the structures are pre-zoning.
  - f Water Source: Show proof of a legal water source.
  - g Access Inspection: Verify that County Access Requirements have been met.

4. The compliance inspector will review the findings from the inspection and determine if the property is in compliance.
  - a. If the property is in compliance the zoning permit will be closed.
  - b. If the property is not in compliance, a letter will be sent to the property owner, certified return receipt, pointing out the non-compliance and how to come into compliance. The property owner will then have to bring the property into compliance within thirty (30) calendar days from the date of notification. The property must be brought into compliance before occupancy.
  - c. After thirty days, a re-inspection will be made of the property. If the matter of non-compliance has not been corrected or an agreement has not been reached by the Planning and Zoning Office with the property owner, the property file will be turned over to the County Attorney for prosecution, as prescribed by the current Custer County Zoning Resolution.

## **RIGHT TO RANCH AND FARM**

Custer County Resolution 98-14, “establishing a right to ranch and farm policy”, was adopted November 4, 1998 and is supported by C.R.S. § 35-3.5-102, which was effective July 1, 1996. The Resolution and Statutes state that an agricultural operation that employs methods or practices commonly or reasonably associated with agricultural production is not a public or private nuisance, particularly if it was in place prior to the initiation of nonagricultural activities in the surrounding neighborhood.

It is the policy of the Board of County Commissioners of Custer County that ranching, farming, and all manner of traditional agricultural activities and operations throughout Custer County are integral elements of and necessary for the continued vitality of the county’s history, economy, landscape, lifestyle and culture. Given their importance to Custer County and Colorado, agricultural lands and operations are worthy of recognition and protection.

Colorado is a “Right to Farm State” pursuant to Section § 35-3.5-101, et seq., Colorado Revised Statutes. Landowners, residents, and visitors must be prepared to accept the activities, sights, sounds and smells of Custer County’s agricultural operations as a normal and necessary aspect of living in a county with a strong rural character and a healthy ranching and farming sector. Those with an urban sensitivity may perceive such activities, sights, sounds and smells as inconveniences, eyesores, noises and odors. However, state law and county policy provides that ranching or other agricultural activities and operations within Custer County shall not be considered to be nuisances, as long as they are operated in conformance with the law and in a non-negligent manner. Therefore, all landowners, residents and visitors must be prepared to encounter noises, odors, lights, mud, dust, smoke, chemicals, machinery on public roads, livestock on public roads, storage and disposal of manure, fertilizers, soil amendments, herbicides and pesticides according to applicable law, any one or more of which may naturally occur as part of legal and non-negligent agricultural operations. In addition, all owners of land, whether ranch or residence, have obligations under state law and county regulation with regard to the maintaining of fences and irrigation ditches, controlling weeds, keeping livestock and pets under control, and other aspects of using and maintaining property. Residents and landowners are encouraged to learn about these rights and responsibilities and to act as good neighbors and citizens of the county.

(The above represents an excerpt from the County Resolution 98-14. Complete copies may be obtained from the Clerk and Recorder.)

# STATE OF COLORADO

Bill Owens, Governor  
Dennis E. Ellis, Executive Director

Dedicated to protecting and improving the health and environment of the people of Colorado

4300 Cherry Creek Dr. S.      Laboratory Services Division  
Denver, Colorado 80246-1530      8100 Lowry Blvd.  
Phone (303) 692-2000      Denver, Colorado 80230-6928  
TDD Line (303) 691-7700      (303) 692-3090  
Located in Glendale, Colorado  
<http://www.cdphe.state.co.us>



Colorado Department  
of Public Health  
and Environment

## BUILDING RENOVATION AND DEMOLITION WHAT YOU NEED TO KNOW!

### ***Are you Remodeling, Renovating or Demolishing?***

You are subject to State and Federal Regulations requiring inspection for asbestos. Avoid penalties and delays: have your project inspected for asbestos by a Colorado-certified asbestos building inspector before commencing work.

### ***It is illegal to improperly disturb asbestos containing materials!***

Asbestos can be found in these and other common building materials: Ceiling textures, vinyl floor coverings and mastic, boiler and pipe insulation, heating and cooling duct insulation, ceiling tile, roofing products, clapboard shingles, etcetera. These materials are regulated; a certified asbestos inspector can determine which materials contain asbestos and which are regulated. Buildings of **any** age may contain asbestos; even those newly built may have asbestos-containing materials.

### ***For ALL Renovation Projects:***

- Buildings of **any** age may contain asbestos; even those newly built may have asbestos containing materials.
- **Inspection:** the structures/components to be disturbed **must be inspected for asbestos** by a state-certified asbestos inspector. Contact CDPHE or go to our web site for a current list of Asbestos Inspectors <http://www.cdphe.state.co.us/ap/asbeshom.asp> or Asbestos Building Inspector Consulting firms can be found in the yellow pages section of most telephone books, under the heading "Asbestos Consulting and Testing".
- If the amount of asbestos-containing material to be disturbed exceeds the following trigger levels than an abatement contractor must remove the material.
  - Trigger levels means amounts of material as follows:
    - With regard to single-family residential dwellings, the trigger levels are 50 linear feet on pipes, 32 square feet on other surfaces, or the volume equivalent of a 55-gallon drum.
    - With regard to all areas other than single-family residential dwellings, the trigger levels are 260 linear feet on pipes, 160 square feet on other surfaces, or the volume equivalent of a 55-gallon drum.
- A certified removal contractor (General Abatement Contractor) must remove asbestos-containing materials that are regulated or may become regulated before they are disturbed by renovation or demolition activities. Contact CDPHE or go to our web site for a current list of General Abatement Contractors <http://www.cdphe.state.co.us/ap/asbeshom.asp> or Contractors can be found in the yellow pages section of most telephone books, under the heading "Asbestos Abatement".
- **Notification:** A **written notification** to CDPHE, payment of a notification fee and **ten (10) working day waiting period** is required before the removal (abatement) of regulated asbestos containing materials.

- Regulated asbestos-containing waste material must be disposed of at an approved asbestos waste disposal site.

## ***Demolitions, Destructive Salvage, House Moving***

If you demolish, perform destructive salvage, perform de-construction, burn, destroy, dismantle, dynamite, implode, knock down, level, pull down, pulverize, raze, tear down, wreck all of a structure or structural components or you move a house you are subject to State and Federal Regulations **even when there is NO asbestos in the facility.**

### *Prior to Demolition:*

- **Inspection:** the building **must be inspected for asbestos** by a state-certified asbestos inspector. Contact CDPHE or go to our web site for a current list of Asbestos Inspectors <http://www.cdphe.state.co.us/ap/asbeshom.asp> or Asbestos Building Inspector Consulting firms can be found in the yellow page section of most telephone books, under the heading "Asbestos Consulting and Testing".
- **Asbestos Removal** (if necessary) must be performed by a Colorado-certified General Abatement Contractor. **Any** asbestos containing material that is friable or will be made friable during demolition activities must be removed prior to demolition. Removal, in accordance with Regulation No. 8, is required if the amount of asbestos-containing material that is friable or will become friable during demolition exceeds the trigger levels.
- **Notification of Demolition Form** must be submitted to the CDPHE, **even if no asbestos was found during the inspection**, payment of a notification fee and **ten (10) working day waiting period** is required before the demolition can proceed.

### *During Demolition:*

- Recycling of materials, such as concrete or wood, that are bonded or contaminated with asbestos-containing material (ACM), such as floor tile or mastic, is NOT permitted.
- Demolition of a building that has non-friable asbestos containing VAT or tar-impregnated roofing materials remaining must be completed without causing the asbestos-containing materials to become friable. Concrete floors covered with floor tile shall be removed in as large sections as possible. Operations such as crushing, pneumatic jacking, etc. of materials containing asbestos are not permitted.
- When imploding or burning a structure, ALL asbestos-containing material, regardless of quantity, must be removed prior to demolition.

## ***For More Information, please contact:***

Asbestos Compliance Assistance Group  
 Asbestos and Demolition Permit Coordinator  
 Phone: (303) 692-3100  
 Fax: (303) 782-0278  
 Toll Free: 1-800-886-7689  
 Web page: <http://www.cdphe.state.co.us/ap/asbeshom.asp>  
 Email address: [asbestos@state.co.us](mailto:asbestos@state.co.us)

All asbestos abatement and demolition permit application forms are available from our web site or by calling the asbestos program.

**HAVE YOUR PROJECT INSPECTED BY A COLORADO-CERTIFIED ASBESTOS  
 BUILDING INSPECTOR BEFORE YOU BEGIN**

**Violation of asbestos regulations can result in monetary penalties and project delays.**



# FORESTRY

---

## Creating Wildfire-Defensible Zones    no. 6.302

by F.C. Dennis <sup>1</sup>

### Quick Facts...

Wildfire will find the weakest links in the defense measures you have taken on your property.

The primary determinants of a home's ability to survive wildfire are its roofing material and the quality of the "defensible space" surrounding it.

Even small steps to protect your home and property will make them more able to withstand fire.

Consider these measures for all areas of your property, not just the immediate vicinity of the house.

Fire is capricious. It can find the weak link in your home's fire protection scheme and gain the upper hand because of a small, overlooked or seemingly inconsequential factor. While you may not be able to accomplish all measures below (and there are no guarantees), each will increase your home's, and possibly your family's, safety and survival during a wildfire.

Start with the easiest and least expensive actions. Begin your work closest to your house and move outward. Keep working on the more difficult items until you have completed your entire project.

### Defensible Space

Two factors have emerged as the primary determinants of a home's ability to survive wildfire. These are the home's roofing material and the quality of the "defensible space" surrounding it.

Use fire-resistive materials (Class C or better rating), not wood or shake shingles, to roof homes in or near forests and grasslands. When your roof needs significant repairs or replacement, do so with a fire-resistant roofing material. Check with your county building department. Some counties now restrict wood roofs or require specific classifications of roofing material.

Defensible space is an area around a structure where fuels and vegetation are treated, cleared or reduced to slow the spread of wildfire towards the structure. It also reduces the chance of a structure fire moving from the building to the surrounding forest. Defensible space provides *room for firefighters to do their jobs*. Your house is more likely to withstand a wildfire if grasses, brush, trees and other common forest fuels are managed to reduce a fire's intensity.

The measure of fuel hazard refers to its continuity, both horizontal (across the ground) and vertical (from the ground up into the vegetation crown). Fuels with a high degree of both vertical and horizontal continuity are the most hazardous, particularly when they occur on slopes. Heavier fuels (brush and trees) are more hazardous (i.e. produce a more intense fire) than light fuels such as grass.

Mitigation of wildfire hazards focuses on breaking up the continuity of horizontal and vertical fuels. Additional distance between fuels is required on slopes.

Creating an effective defensible space involves developing a series of management zones in which different treatment techniques are used. See Figure 1 for a general view of the relationships among these management zones. Develop defensible space around each building on your property. Include detached garages, storage buildings, barns and other structures in your plan.

The actual design and development of your defensible space depends on several factors: size and shape of buildings, materials used in their construction, the slope of the ground on which the structures are built, surrounding topography, and sizes and types of vegetation on your property. These factors all affect your

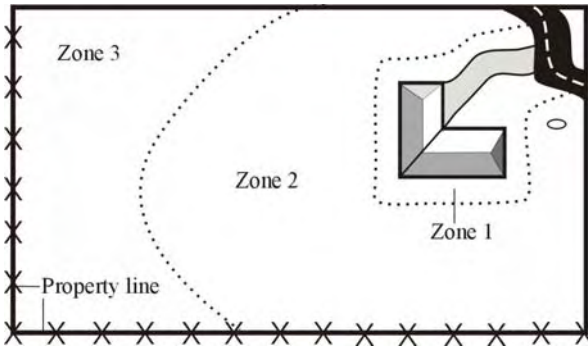

Figure 1: Forested property showing the three fire-defensible zones around a home or other structure.

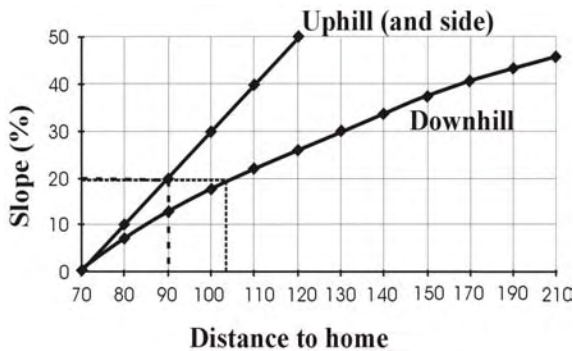

Figure 2: This chart indicates the minimum recommended dimensions for defensible space from the home to the outer edge of Zone 2. For example, if your home is situated on a 20 percent slope, the minimum defensible space dimensions would be 90 feet uphill and to the sides of the home and 104 feet downhill from the home.

design. You may want to request additional guidance from your local Colorado State Forest Service (CSFS) forester or fire department. (See the Special Recommendations section of this fact sheet for shrubs, lodgepole pine, Engelmann spruce, and aspen.)

## Defensible Space Management Zones

**Zone 1** is the area of maximum modification and treatment. It consists of an area of 15 feet around the structure in which all flammable vegetation is removed. This 15 feet is measured from the outside edge of the home’s eaves and any attached structures, such as decks.

**Zone 2** is an area of fuel reduction. It is a transitional area between Zones 1 and 3. The size of Zone 2 depends on the slope of the ground where the structure is built. Typically, the defensible space should extend *at least* 75 to 125 feet from the structure. See Figure 2 for the appropriate distance for your home’s defensible space. Within this zone, the continuity and arrangement of vegetation is modified. Remove stressed, diseased, dead or dying trees and shrubs. Thin and prune the remaining larger trees and shrubs. Be sure to extend thinning along either side of your driveway all the way to your main access road. These actions help eliminate the continuous fuel surrounding a structure while enhancing homesite safety and the aesthetics of the property.

**Zone 3** is an area of traditional forest management and is of no particular size. It extends from the edge of your defensible space to your property boundaries.

## Prescriptions

### Zone 1

The size of Zone 1 is 15 feet, measured from the edges of the structure. Within this zone, several specific treatments are recommended.

Plant nothing within 3 to 5 feet of the structure, particularly if the building is sided with wood, logs or other flammable materials. Decorative rock, for example, creates an attractive, easily maintained, nonflammable ground cover.

If the house has noncombustible siding, widely spaced foundation plantings of low growing shrubs or other “fire wise” plants are acceptable. Do not plant directly beneath windows or next to foundation vents. Be sure there are no areas of continuous grass adjacent to plantings in this area.

Frequently prune and maintain plants in this zone to ensure vigorous growth and a low growth habit. Remove dead branches, stems and leaves.

Do not store firewood or other combustible materials in this area. Enclose or screen decks with metal screening. Extend the gravel coverage under the decks. Do not use areas under decks for storage.

Ideally, remove all trees from Zone 1 to reduce fire hazards. If you do keep a tree, consider it part of the structure and extend the distance of the entire defensible space accordingly. Isolate the tree from any other surrounding trees. Prune it to at least 10 feet above the ground. Remove any branches that interfere with the roof or are within 10 feet of the chimney. Remove all “ladder fuels” from beneath the tree. Ladder fuels are vegetation with vertical continuity that allows fire to burn from ground level up into the branches and crowns of trees. Ladder fuels are potentially very hazardous but are easy to mitigate. No ladder fuels can be allowed under tree canopies. In all other areas, prune all branches of shrubs or trees up to a height of 10 feet above ground (or 1/2 the height, whichever is the least).



## Zone 2

Zone 2 is an area of fuel reduction designed to reduce the intensity of any fire approaching your home. Follow these recommended management steps.

Thin trees and large shrubs so there is at least 10 feet between crowns. Crown separation is measured from the furthest branch of one tree to the nearest branch on the next tree (Figure 3). On steep slopes, allow more space between tree crowns. (See Figure 4 for *minimum recommended* spacing for trees on steep slopes.) Remove all ladder fuels from under these remaining trees. Carefully prune trees to a height of at least 10 feet.

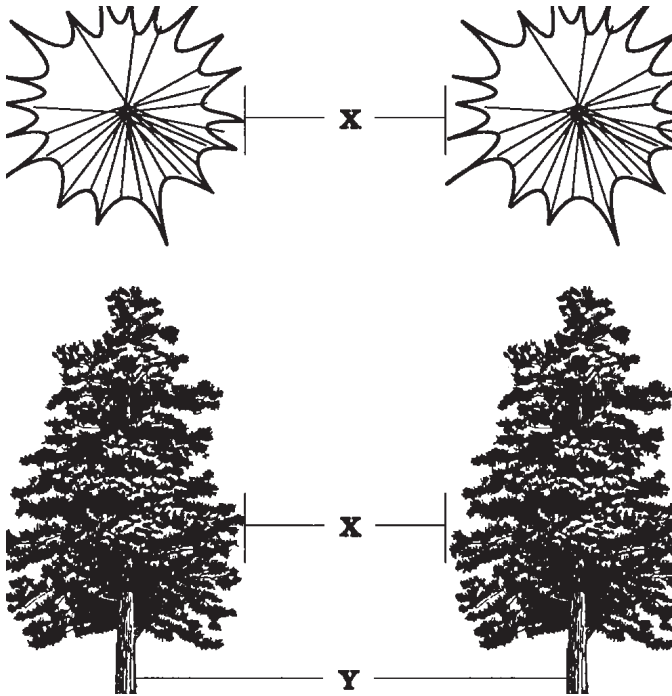

Figure 3: X = crown spacing; Y = stem spacing. Do not measure between stems for crown — measure between the edges of tree crowns.

Small clumps of 2 to 3 trees may be occasionally left in Zone 2. Leave more space between the crowns of these clumps and surrounding trees.

Because Zone 2 forms an aesthetic buffer and provides a transition between zones, it is necessary to blend the requirements for Zones 1 and 3. Thin the portions of Zone 3 adjacent to Zone 2 more heavily than the outer portions.

Isolated shrubs may remain, provided they are not under tree crowns. Prune and maintain these plants periodically to maintain vigorous growth. Remove dead stems from trees and shrubs annually. Where shrubs are the primary fuel in Zone 2, refer to the Special Recommendations section of this fact sheet.

Limit the number of dead trees (snags) retained in this area. Wildlife needs only one or two snags per acre. Be sure any snags left for wildlife cannot fall onto the house or block access roads or driveways.

Mow grasses (or remove them with a weed trimmer) as needed through the growing season to keep them low, a maximum of 6 to 8 inches. This is extremely critical in the fall when grasses dry out and cure or in the spring after the snow is gone but before the plants green up.

Stack firewood and woodpiles uphill or on the same elevation as the structure but at least 30 feet away. Clear and keep away flammable vegetation within 10 feet of these woodpiles. Do not stack wood against your house or on or under your deck, even in winter. Many homes have burned from a woodpile that ignited as the fire passed. Wildfires can burn at almost any time in Colorado.

Locate propane tanks at least 30 feet from any structures, preferably on the same elevation as the house. You don't want the LP container below your house — if it ignites, the fire would tend to burn uphill. On the other hand, if the tank is above your house and it develops a leak, LP gas will flow downhill into your home. Clear and keep away flammable vegetation within 10 feet of these tanks. Do not screen propane tanks with shrubs or vegetation.

% slope	Tree Crown Spacing	Brush and Shrub Clump Spacing
0 -10 %	10'	2 1/2 x shrub height
11 - 20%	15'	3 x shrub height
21 - 40%	20'	4 x shrub height
> 40%	30'	6 x shrub height

Figure 4: Minimum tree crown and shrub clump spacing.

Tree Diameter	Average Stem Spacing Between Trees
3	10
4	11
5	12
6	13
7	14
8	15
9	16
10	17
11	19
12	21
13	23
14	24
15	26
16	28
17	29
18	31
19	33
20	35
21	36
22	38
23	40
24	42

Figure 5: Minimum tree spacing for Zone 3.

Dispose of slash (limbs, branches and other woody debris) from your trees and shrubs through chipping or by piling and burning. Contact your local CSFS office or county sheriff’s office for information about burning slash piles. If neither of these alternatives is possible, lop and scatter slash by cutting it into very small pieces and distributing it over the ground. Avoid heavy accumulations of slash. Lay it close to the ground to speed decomposition. If desired, no more than two or three small, widely spaced brush piles may be left for wildlife purposes. Locate these towards the outer portions of your defensible space.

### Zone 3

This zone is of no specified size. It extends from the edge of your defensible space to your property lines. A gradual transition into this zone from defensible space standards to other management objectives you may have is suggested. Typical management objectives for areas surrounding homesites or subdivisions are: provide optimum recreational opportunities; enhance aesthetics; maintain tree health and vigor; provide barriers for wind, noise, dust and visual intrusions; support limited production of firewood, fence posts and other forest commodities; or grow Christmas trees or trees for transplanting.

Specific requirements will be dictated by your objectives for your land and the kinds of trees present. See Figure 5 for the *minimum* suggested spacing between “leave” trees. Forest management in Zone 3 is an opportunity for you to increase the health and growth rate of the forest in this zone. Keep in mind that root competition for available moisture limits tree growth and ultimately the health of the forest.

A high canopy forest reduces the chance of a surface fire climbing into the tops of the trees and might be a priority for you if this zone slopes steeply. The healthiest forest is one that has multiple ages, sizes, and species of trees where adequate growing room is maintained over time. Remember to consider the hazards of ladder fuels. Multiple sizes and ages of trees might increase the fire hazard from Zone 3 into Zone 2, particularly on steep slopes.

A greater number of wildlife trees can remain in Zone 3. Make sure that dead trees pose no threat to power lines or fire access roads.

While pruning generally is not necessary in Zone 3, it may be a good idea from the standpoint of personal safety to prune trees along trails and fire access roads. Or, if you prefer the aesthetics of a well-manicured forest, you might prune the entire area. In any case, pruning helps reduce ladder fuels within the tree stand, thus enhancing wildfire safety.

Mowing is not necessary in Zone 3.

Any approved method of slash treatment is acceptable for this zone, including piling and burning, chipping or lop-and-scatter.

## Special Recommendations

Tree spacing guidelines do not apply to *mature* stands of aspen trees where the recommendations for ladder fuels have been complied with. In areas of aspen regeneration and young trees, the spacing guidelines should be followed.

### Brush and shrubs

Brush and shrubs are woody plants, smaller than trees, often formed by a number of vertical or semi-upright branches arising close to the ground. Brush is smaller than shrubs and can be either woody or herbaceous vegetation.

On nearly level ground, minimum spacing recommendations between clumps of brush and/or shrubs is 2 1/2 times the height of the vegetation. Maximum diameter of clumps should be 2 times the height of the vegetation. As with tree crown spacing, all measurements are made from the edges of vegetation crowns (Figure 3).

For example: For shrubs 6 feet high, spacing between shrub clumps should be 15 feet or more apart (measured from the edges of the crowns of vegetation clumps). The diameter of shrub clumps should not exceed 12 feet (measured from the edges of the crowns). Branches should be pruned to a height of 3 feet.

### Grasses

Keep dead, dry or curing grasses mowed to less than 6 inches. Defensible space size where grass is the predominant fuel can be reduced (Figure 5) when applying this practice.

### Windthrow

In Colorado, certain locations and tree species, including lodgepole pine and Engelmann spruce, are especially susceptible to damage and uprooting by high winds (windthrow). If you see evidence of this problem in or near your forest, or have these tree species, consider the following adjustments to the defensible space guidelines. It is highly recommended that you contact a professional forester to help design your defensible space.

**Adjustments:** If your trees or homesite are susceptible to windthrow and the trees have never been thinned, use a stem spacing of diameter plus five instead of the guides listed in the Zone 3 section. Over time (every 3 to 5 years) *gradually* remove additional trees. The time between cutting cycles allows trees to “firm up” by expanding their root systems. Continue this periodic thinning until the desired spacing is reached.

Also consider leaving small clumps of trees and creating small openings on their lee side (opposite of the predominant wind direction). Again, a professional forester can help you design the best situation for your specific homesite and tree species. Remember, with species such as lodgepole pine and Engelmann spruce, the likelihood of a wildfire running through the tree tops or crowns (crowning) is closely related to the overabundance of fuels on the forest floor. Be sure to remove downed logs, branches and *excess* brush and needle buildup.

% slope	D-space size (uphill, downhill, sidehill)
0 - 20 %	30'
21 - 40%	50'
> 40%	70'

Figure 6: Minimum defensible space size for grass fuels.

## Maintaining Your Defensible Space

Your home is located in a forest that is dynamic, always changing. Trees and shrubs continue to grow, plants die or are damaged, new plants begin to grow, and plants drop their leaves and needles. Like other parts of your home, defensible space requires maintenance. Use the following checklist each year to determine if additional work or maintenance is necessary.

### Defensible Space and FireWise Annual Checklist

- Trees and shrubs are properly thinned and pruned within the defensible space. Slash from the thinning is disposed of.
- Roof and gutters are clear of debris.
- Branches overhanging the roof and chimney are removed.
- Chimney screens are in place and in good condition.
- Grass and weeds are mowed to a low height.
- An outdoor water supply is available, complete with a hose and nozzle that can reach all parts of the house.
- Fire extinguishers are checked and in working condition.
- The driveway is wide enough. The clearance of trees and branches is adequate for fire and emergency equipment. (Check with your local fire department.)
- Road signs and your name and house number are posted and easily visible.



FIREWISE is a multi-agency program that encourages the development of defensible space and the prevention of catastrophic wildfire.

- There is an easily accessible tool storage area with rakes, hoes, axes and shovels for use in case of fire.
- You have practiced family fire drills and your fire evacuation plan.
- Your escape routes, meeting points and other details are known and understood by all family members.
- Attic, roof, eaves and foundation vents are screened and in good condition. Stilt foundations and decks are enclosed, screened or walled up.
- Trash and debris accumulations are removed from the defensible space.
- A checklist for fire safety needs inside the home also has been completed. This is available from your local fire department.

## References

Colorado State Forest Service, Colorado State University, Fort Collins, CO 80523-5060; (970) 491-6303:

- *FireWise Construction — Design and Materials*
- *Home Fire Protection in the Wildland Urban Interface*
- *Wildfire Protection in the Wildland Urban Interface*
- *Landowner Guide to Thinning*

Colorado State University Cooperative Extension, 115 General Services Bldg., Fort Collins, CO 80523-4061; (970) 491-6198;

E-mail: resourcecenter@ucm.colostate.edu:

- 6.303, *Fire-Resistant Landscaping*
- 6.304, *Forest Home Fire Safety*
- 6.305, *FireWise Plant Materials*
- 6.306, *Grass Seed Mixes to Reduce Wildfire Hazard*
- 7.205, *Pruning Evergreens*
- 7.206, *Pruning Shrubs*
- 7.207, *Pruning Deciduous Trees*

**Colorado  
State**  
FOREST  
SERVICE

This fact sheet was produced in cooperation with the Colorado State Forest Service.

<sup>1</sup>Wildfire Hazard Mitigation Coordinator,  
Colorado State Forest Service.

Issued in furtherance of Cooperative Extension work, Acts of May 8 and June 30, 1914, in cooperation with the U.S. Department of Agriculture, Milan A. Rewerts, Director of Cooperative Extension, Colorado State University, Fort Collins, Colorado. Cooperative Extension programs are available to all without discrimination. No endorsement of products mentioned is intended nor is criticism implied of products not mentioned.



# FORESTRY

---

## Fire-Resistant Landscaping

no. 6.303

by F.C. Dennis<sup>1</sup>

### Quick Facts...

More people are moving into Colorado's rural areas, increasing the chances of wildfire.

"Defensible space" is the primary determinant of a structure's ability to survive wildfire.

Native species are generally the best plant materials for landscaping in defensible space, but others can be grown successfully in Colorado.

To be a FireWise homeowner, plan well, plant well and maintain well.

Colorado's population is growing, its urban areas are rapidly expanding, and people are building more homes in what was once natural forest and brushlands. Newcomers to rural areas need to know how to correctly landscape their property to reduce wildfire hazards.

Improper landscaping worries land managers and fire officials because it can greatly increase the risk of structure and property damage from wildfire. It is a question of *when*, not *if*, a wildfire will strike any particular area.

Vegetative clearance around the house (defensible space) is a primary determinant of a home's ability to survive wildfire. Defensible space is, simply, room for firefighters to do their job. If grasses, brush, trees and other common forest fuels are removed, reduced, or modified to lessen a fire's intensity and keep it away from the home, chances increase that the structure will survive. It is a little-known fact that in the absence of a defensible space, firefighters will often bypass a house, choosing to make their stand at a home where their safety is more assured and the chance to successfully protect the structure is greater.

### Landscaping Defensible Space

People often resist creating defensible space because they believe that it will be unattractive, unnatural and sterile-looking. It doesn't have to be! Wise landowners carefully plan landscaping within the defensible space. This effort yields a many-fold return of beauty, enjoyment and added property value. Development of defensible space is outlined in fact sheet 6.302, *Creating Wildfire-Defensible Zones*.

Colorado has great diversity in climate, geology and vegetation. Home and cabin sites can be found from the foothills through 10,000-foot elevations. Such extremes present a challenge in recommending plants. While native plant materials generally are best, a wide range of species can be grown successfully in Colorado.

Many plant species are suitable for landscaping in defensible space. Use restraint and common sense, and pay attention to plant arrangement and maintenance. It has often been said that *how* and *where* you plant are more important than *what* you plant. While this is indeed true, given a choice among plants, choose those that are more resistant to wildfire.

Consider the following factors when planning, designing and planting the FireWise landscape within your home's defensible space:

- Landscape according to the recommended defensible-space zones. That is, the plants near your home should be more widely spaced and lower growing than those farther away.
- Do not plant in large masses. Instead, plant in small, irregular clusters or islands.

**Colorado  
State**  
University  
Cooperative  
Extension

© Colorado State University  
Cooperative Extension. 5/99.  
[www.colostate.edu/Depts/CoopExt](http://www.colostate.edu/Depts/CoopExt)

The best tree species to plant generally are those naturally occurring on or near the site.

Mow grass short around shrubs.

Plant low-growing, nonresinous shrubs near structures.

Keep grass mown around structures to a maximum of 8 inches.

Plant wildflowers near structures only if they are well-irrigated and cut back during the dormant season.

Gravel area or mow grass short next to the structure.

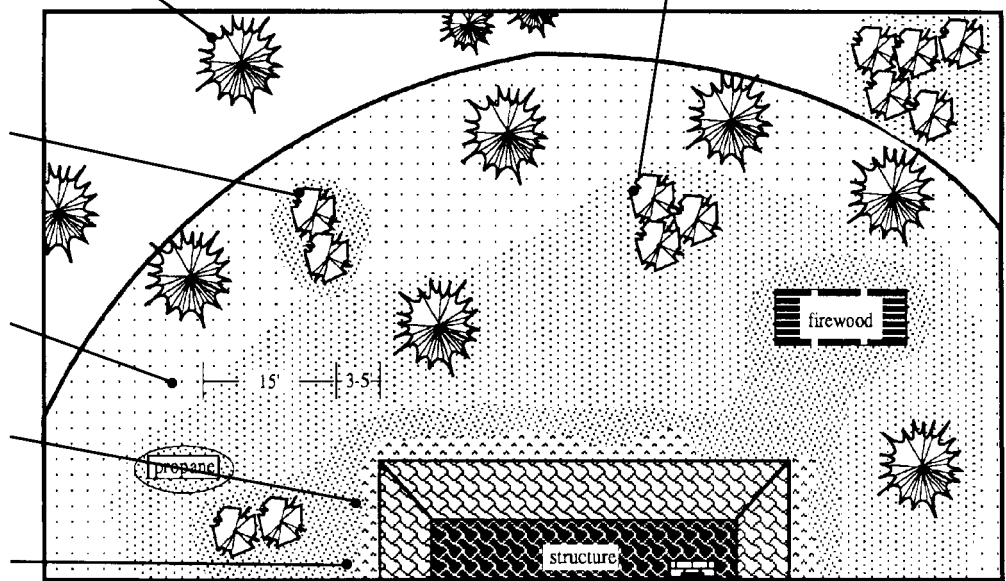

Figure 1: Forested property surrounding a homesite; shows optimum placement of vegetation near the structure.

- Use decorative rock, gravel and stepping stone pathways to break up the continuity of the vegetation and fuels. This can modify fire behavior and slow the spread of fire across your property.
- Incorporate a diversity of plant types and species in your landscape. Not only will this be visually satisfying, but it should help keep pests and diseases from causing problems within the whole landscape.
- In the event of drought and water rationing, prioritize plants to be saved. Provide available supplemental water to plants closest to your house.
- Use mulches to conserve moisture and reduce weed growth. Mulch can be organic or inorganic. Do not use pine bark, thick layers of pine needles or other mulches that readily carry fire.
- Be creative! Further vary your landscape by including bulbs, garden art and containers for added color.

## References

- 6.302, Creating Wild-Fire Defensible Zones
- 6.304, Forest Home Fire Safety
- 6.305, FireWise Plant Materials
- 6.306, Grass Seed Mixes to Reduce Wildfire Hazard
- 7.205, Pruning Evergreens
- 7.206, Pruning Shrubs
- 7.207, Pruning Deciduous Trees
- 7.233, Wildflowers for Colorado
- 7.406, Flowers for Mountain Communities
- 7.407, Shrubs for Mountain Communities
- 7.408, Trees for Mountain Communities
- 7.413, Ground Covers for Mountain Communities

## Grasses

During much of the year, grasses ignite easily and burn rapidly. Tall grass will quickly carry fire to your house. Mow grasses low in the inner zones of the defensible space. Keep them short closest to the house and gradually increase height outward from the house, to a maximum of 8 inches. This is particularly important during fall, winter and before green-up in early spring, when grasses are dry, dormant and in a “cured” fuel condition. Given Colorado’s extremely variable weather, wildfires can occur any time of the year. Maintenance of the grassy areas around your home is critical.

Mow grasses low around the garage, outbuildings, decks, firewood piles, propane tanks, shrubs, and specimen trees with low-growing branches.

## Ground Cover Plants

Replace bare, weedy or unsightly patches near your home with ground covers, rock gardens, vegetable gardens and mulches. Ground cover plants are a good alternative to grass for parts of your defensible space. They break up the monotony of grass and enhance the beauty of your landscape. They provide a



Figure 2: Ladder fuels enable fire to travel from the ground surface into shrubs and then into the tree canopy.

variety of textures and color and help reduce soil erosion. Consider ground cover plants for areas where access for mowing or other maintenance is difficult, on steep slopes and on hot, dry exposures.

Ground cover plants are usually low growing. They are succulent or have other FireWise characteristics that make them useful, functional and attractive. When planted in beds surrounded by

walkways and paths, in raised beds or as part of a rock garden, they become an effective barrier to fire spread. The ideal groundcover plant is one which will spread, forming a dense mat of roots and foliage that reduces soil erosion and excludes weeds.

Mulch helps control erosion, conserve moisture and reduce weed growth. It can be organic (compost, leaf mold, bark chips, shredded leaves) or it can be inorganic (gravel, rock, decomposing granite).

When using organic mulches, use just enough to reduce weed and grass growth. Avoid thick layers. When exposed to fire, they tend to smolder and are difficult to extinguish. Likewise, while your property might yield an abundance of needles from your native pines or other conifers, don't use them as mulch because they can readily catch and spread wildfire. Rake, gather and dispose of them often within your defensible space.

## Wildflowers

Wildflowers bring variety to a landscape and provide color from May until frost. Wildflower beds give a softer, more natural appearance to the otherwise manicured look often resulting from defensible space development.

A concern with wildflowers is the tall, dense areas of available fuel they can form, especially in dormancy. To reduce fire hazard, plant wildflowers in widely separated beds within the defensible space. Do not plant them next to structures unless the beds are frequently watered and weeded and vegetation is promptly removed after the first hard frost. Use gravel walkways, rock retaining walls or irrigated grass areas mowed to a low height to isolate wildflower beds from each other and from other fuels.

## Shrubs

Shrubs lend color and variety to the landscape and provide cover and food for wildlife. However, shrubs concern fire professionals because, as the next level in the "fuel continuum," they can add significantly to total fuel loading. Because of the woody material in their stems and branches, they are a potential source of fire brands. When carried in the smoke column ahead of the main fire, fire brands can rapidly spread the fire in a phenomenon known as "spotting."

But the primary concern with shrubs is that they are a "ladder fuel" – they can carry a relatively easy-to-control surface grass fire into tree crowns. Crown fires are difficult, sometimes impossible, to control (see Figure 2).

To reduce the fire-spreading potential of shrubs, plant only widely separated, low-growing, nonresinous varieties close to structures. Do not plant them directly beneath windows or vents or where they might spread under wooden decks. Do not plant shrubs under tree crowns or use them to screen propane tanks, firewood piles or other flammable materials. Plant shrubs individually, as specimens, or in small clumps apart from each other and away from any trees within the defensible space.

Mow grasses low around shrubs. Prune dead stems from shrubs annually. Remove the lower branches and suckers from species such as Gambel oak to raise the canopy away from possible surface fires.

### **Structural Elements of a FireWise Landscape**

*When building a deck or patio, use concrete, flagstone or rock instead of wood. These materials do not burn and do not collect flammable debris like the space between planks in wooden decking.*

*Where appropriate on steeper ground, use retaining walls to reduce the steepness of the slope. This, in turn, reduces the rate of fire spread. Retaining walls also act as physical barriers to fire spread and help deflect heat from the fire upwards and away from structures.*

*Rock or masonry walls are best, but even wooden tie walls constructed of heavy timbers will work. Put out any fires burning on tie walls after the main fire front passes.*

*On steep slopes, consider building steps and walkways around structures. This makes access easier for home maintenance and enjoyment. It also serves as a physical barrier to fire spread and increases firefighters' speed and safety as they work to defend your home.*



FIREWISE is a multi-agency program that encourages the development of defensible space and the prevention of catastrophic wildfire.



This fact sheet was produced in cooperation with the Colorado State Forest Service.

<sup>1</sup> Wildfire Hazard Mitigation Coordinator, Colorado State Forest Service.

## Trees

Trees provide a large amount of available fuel for a fire and can be a significant source of fire brands if they do burn. Radiant heat from burning trees can ignite nearby shrubs, trees and structures.

Colorado's elevation and temperature extremes limit tree selection. The best species to plant generally are those already growing on or near the site. Others may be planted with careful selection and common sense.

If your site receives enough moisture to grow them, plant deciduous trees such as aspen or narrow-leaf cottonwood. These species, even when planted in dense clumps, generally do not burn well, if at all. The greatest problem with these trees is the accumulation of dead leaves in the fall. Remove accumulations close to structures as soon as possible after leaf drop.

When site or available moisture limits recommended species to evergreens, carefully plan their placement. Do not plant trees near structures. Leave plenty of room between trees to allow for their growth. Spacing within the defensible space should be at least 10 feet between the edges of tree crowns. On steep ground, allow even more space between crowns. Plant smaller trees initially on a 20- to 25-foot spacing to allow for tree growth. At some point, you will have to thin your trees to retain proper spacing.

As the trees grow, prune branches to a height of 10 feet above the ground. Do not overprune the crowns. A good rule of thumb is to remove no more than one-third of the live crown of the tree when pruning. Prune existing trees as well as ones you planted.

Some trees (for example, Colorado blue spruce) tend to keep a full crown. Other trees grown in the open may also exhibit a full growth habit. Limit the number of trees of this type within the defensible space. Prune others as described above and mow grasses around such specimen trees.

## Maintenance

A landscape is a dynamic system that constantly grows and changes. Plants considered fire resistant and that have low fuel volumes can lose these characteristics over time. Your landscape, and the plants in it, must be maintained to retain their FireWise properties.

- Always keep a watchful eye towards reducing the fuel volumes available to fire. Be aware of the growth habits of the plants within your landscape and of the changes that occur throughout the seasons.
- Remove annuals and perennials after they have gone to seed or when the stems become overly dry.
- Rake up leaves and other litter as it builds up through the season.
- Mow or trim grasses to a low height within your defensible space. This is particularly important as grasses cure.
- Remove plant parts damaged by snow, wind, frost or other agents.
- Timely pruning is critical. Pruning not only reduces fuel volumes but also maintains healthier plants by producing more vigorous, succulent growth.
- Landscape maintenance is a critical part of your home's defense system. Even the best defensible space can be compromised through lack of maintenance. The old adage "An ounce of prevention is worth a pound of cure" applies here.

Issued in furtherance of Cooperative Extension work, Acts of May 8 and June 30, 1914, in cooperation with the U.S. Department of Agriculture, Milan A. Rewerts, Director of Cooperative Extension, Colorado State University, Fort Collins, Colorado. Cooperative Extension programs are available to all without discrimination. No endorsement of products mentioned is intended nor is criticism implied of products not mentioned.



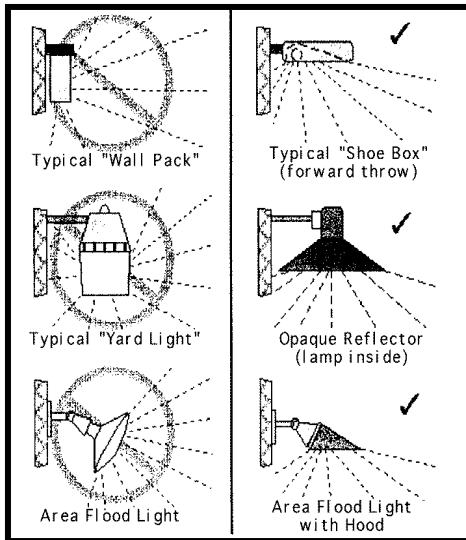

Custer County is in the enviable position of starting with mostly dark skies today. Please illuminate carefully. Picking the right fixture and bulb type for your needs will yield quality of life dividends for all of us.

It is a win-win situation: glare and upward light pollution have no benefit; they only reduce the effectiveness of well modulated, useful light.

<u>Bulb Type</u>	<u>Lumens Per Watt</u>
Incandescent	20
Mercury vapor	54
Metal halide	80
High-pressure sodium	125
Low-press sodium	183
LUMENS = the amount of light	
WATTS = the amount of electricity	
MERCURY VAPOR:	
175 watt = 7140 lumens = annual cost of \$70.26 @ \$0.10 / kwh	
HIGH PRESSURE SODIUM:	
100 watt = 8550 lumens = annual cost of \$40.14 @ \$0.10 / kwh	

For more information, contact:  
**DARK SKIES**  
 P.O. Box 634  
 Westcliffe, CO 81252  
[www.wetmndarkskies.org](http://www.wetmndarkskies.org)

Want to talk to a real person? You can call: Bob Gilchrist 719-783-2944; Sam Frostman 719-783-0252; Tom Larkin 719-783-9271; or Smokey Jack 719-783-2935.

March-2003

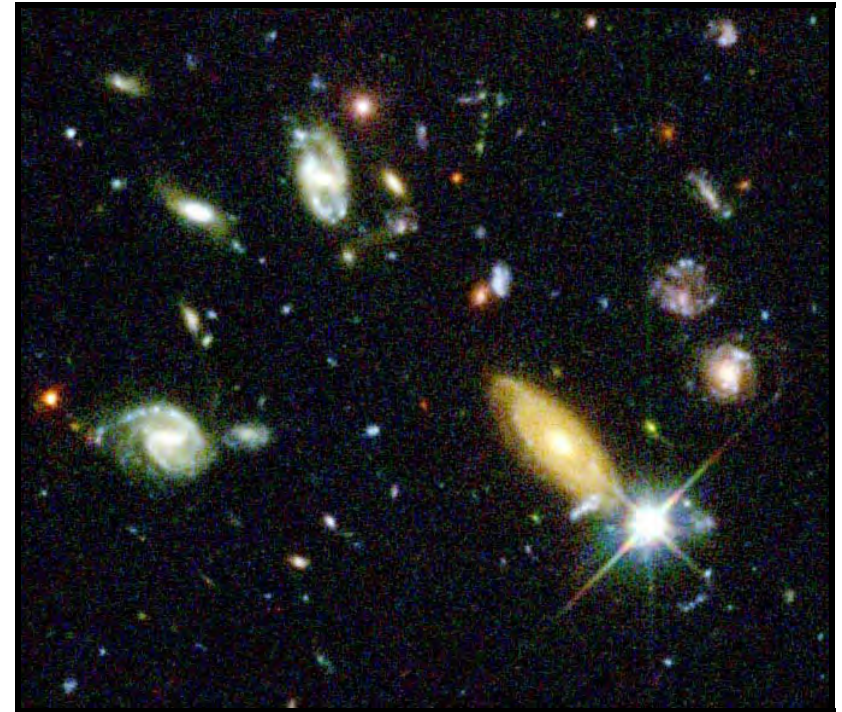

Detail from Hubble deep field image - NASA

*Is the night sky worth saving?*

*We think so.*



[www.wetmndarkskies.org](http://www.wetmndarkskies.org)

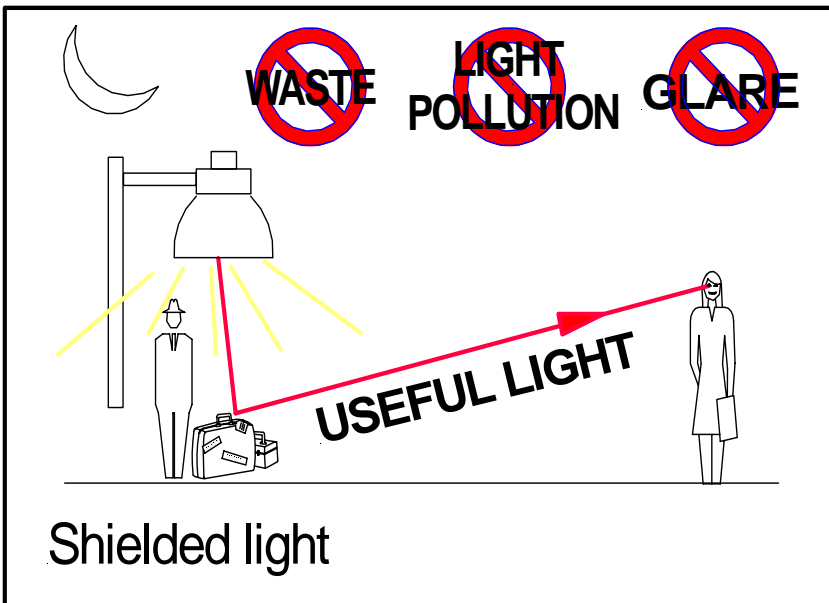
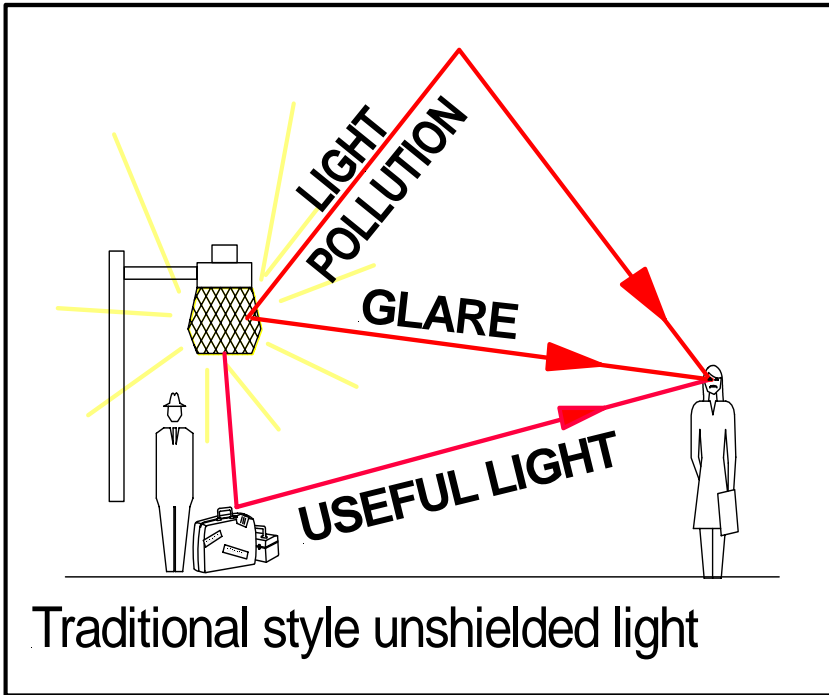

Today the Wet Mountain Valley is a lightly populated rural area with spectacular night skies. You can do your part to help preserve this resource by installing well designed outdoor lighting.

Unshielded lights broadcast glare for tens of miles. An unshielded yard light viewed across the valley through our crystal clear air is many times brighter than the brightest star.

Upward directed stray beams from unshielded or open-top lights reflect from particles in the atmosphere and cause 'sky glow' that obscures the millions of dimmer stars. We already see the sky glow of Pueblo and Canon City, we need to take care before our dark skies are gone, one light at a time!

All outdoor lights should feature:

- ☑ **No escape of light in an upward direction.** This will eliminate light pollution and save our night skies.
- ☑ **A shaded source of illumination.** This will prevent glare and show consideration for neighbors.

Dark Skies is an emerging concern nationwide and more dark-sky-friendly fixtures are available every day. Visit our web site or call a volunteer to find out where you can purchase good lighting.

Dark Skies always has Hubble hoods on hand – we will sell you a hood or give you a hood – whatever it takes to save our skies! Hubble hoods are for yard lights, they feature a parabolic reflector that provides optimum light distribution.

If you decide to lease a security light from a power company, be sure to specify a shielded luminaire when ordering.

# Mountain Pine Beetle

Mountain pine beetle, *Dendroctonus ponderosae*, is an insect native to the forests of western North America. Previously called the Black Hills beetle or Rocky Mountain pine beetle, periodic outbreaks of the insect can result in losses of millions of trees. Outbreaks develop irrespective of property lines, being equally evident in wilderness areas, mountain subdivisions, and back yards. Even windbreak or landscape pines many miles from the mountains can succumb to beetles imported in infested firewood.

## Signs and Symptoms of Mountain Pine Beetle Attack

Popcorn-shaped masses of resin, called "pitch tubes", on the trunk where beetle tunneling begins. Pitch tubes may be brown, pink, or white in color.

Boring dust in bark crevices and on the ground immediately adjacent to the tree base.

Evidence of woodpecker feeding on trunk. Patches of bark are removed and bark flakes lie on ground or snow below the tree.

Foliage turning yellowish to reddish throughout the entire tree crown. Usually occurs eight to ten months after a successful mountain pine beetle attack.

Presence of live mountain pine beetle (eggs, larvae, pupae, and/or adults) as well as galleries under bark. This is the most certain indicator of infestation. A hatchet for removal of bark is needed to check trees correctly.

Bluestained sapwood. Check at more than one point around the tree's circumference.

## Control

Natural controls of mountain pine beetle include woodpeckers and insects such as clerid beetles that feed on mountain pine beetle adults and larvae under bark. Extreme cold temperatures also can reduce the mountain pine beetle populations. However, during outbreaks these natural controls often fail to prevent additional attacks.

Perhaps the most important natural control is tree vigor. Healthy trees are less attractive to beetles than those under stress. Vigorously growing trees also have better defenses that allow them to "pitch out" pine beetles.

Cultural controls that promote tree health and spacing are the primary means to prevent mountain pine beetle outbreaks. The best long-term means to minimize mountain pine beetle losses is to thin trees. Consult a professional forester to select the best cultural practices for your land.

Logs infested with mountain pine beetles can be treated in various ways to kill developing beetles before they emerge as adults in summer. Logs may be burned, preferably in the fireplace, to kill the larvae under the bark. Intense solar radiation that dries out the cambium and raises temperatures to lethal levels (110+ degrees F) can kill mountain pine beetle larvae. Beetles also die if the bark is removed by peeling or milling. Burying is another option to kill mountain pine beetle in infested logs. In some cases, hauling infested logs to "safe sites" a mile or more from susceptible tree hosts also is practiced. Following beetle emergence, wood can be used without threat to other trees.

Certain formulations of carbaryl (Sevin and other) are registered for use to prevent attacks on individual trees. These sprays are applied to living green trees in early summer to kill or deter attacking beetles. This preventive spray is quite effective through one mountain pine beetle flight (one year) in Ponderosa pine areas. In Lodgepole pine areas, recent evidence indicates one spraying may provide satisfactory protection through two flights (two years).

Always carefully read and follow all label precautions before applying carbaryl for mountain pine beetle prevention.

## Infested Trees

Once mountain pine beetles infest a tree, nothing practical can be done to save that particular tree. Under epidemic or outbreak conditions, enough beetles can emerge from an infested tree to kill about two same-sized trees the following year.

Ips and related beetles that emerge early in summer often are mistaken for mountain pine beetle, leading to early reports that "mountain pine beetle is flying". Be sure to properly identify the beetles you find associated with your trees.

Trees from which mountain pine beetles have already emerged (look for numerous round, pitch-free exit holes in bark) do not need to be treated.

The direction and spread rate of a beetle infestation is impossible to predict. However, attacked trees usually are adjacent or near previously killed trees.

**There is a wealth of information on this, and many other topics, available from the Custer County Co-operative Extension Service, located on the second floor of the Custer County Courthouse.**

**Custer County  
Extension**

P. O. Box 360  
Westcliffe, Colorado 81252  
(719) 783-2514  
Fax: (719) 783-0908  
E-mail: [custer@ext.colostate.edu](mailto:custer@ext.colostate.edu)

Dear Prospective Custer County Resident,

We are pleased that you are considering purchasing, or have purchased property in Custer County! This letter is to help answer many of the questions we are asked about living in Custer County.

With the elevation of home sites varying from 7000 feet to nearly 11,000 feet, there are many challenges with altitude that you may not have encountered before.

- The population of Custer County is approximately 4300 full time residents.
- Our growing season, according to statistical data compiled by NOAA, averages about 72 days
- We can expect approximately 45 frost free days
- Time of last killing frost varies but is usually mid to late May.
- Time of first killing frost also varies but generally falls about mid-September.
- Average annual precipitation (including snowfall) is 15.35 inches
- Average annual maximum temperature is 59.6 degrees Fahrenheit
- Average annual minimum temperature is 25.6 degrees Fahrenheit
- Average total snowfall is 86.8 inches
- Production agriculture is mostly cattle and hay production. Nearly all hay production takes place on flood irrigated fields, mountain run off being the source of irrigation water.

The Custer County office of Colorado State University Extension has information available covering most situations new and old that resident's face. Stop by or give us a call to access this information.

Sincerely,



Robin Young

Colorado State University Extension, Custer County Director



Please take a moment and register your cell phone in order to receive important emergency notifications, such as evacuations orders due to wildfire.

You may register online by going to [custercountygov.com](http://custercountygov.com) and then follow the link in the CODE RED box.

-OR-

Fill out the below information, drop it off or mail it to the Sheriff's Department at 702 Rosita Avenue, Westcliffe, CO 81252 and let us register it for you.

Name \_\_\_\_\_

Address \_\_\_\_\_  
Physical address (no P.O. Boxes)

City \_\_\_\_\_

State \_\_\_\_\_

Zip Code \_\_\_\_\_

Phone #1 \_\_\_\_\_

Please Circle Mobile Provider

- Alltel
- AT&T
- Cricket
- Sprint
- T-Mobile
- US Cellular
- Verizon

Phone #2 \_\_\_\_\_

Please Circle Mobile Provider

- Alltel
- AT&T
- Cricket
- Sprint
- T-Mobile
- US Cellular
- Verizon

Email Address \_\_\_\_\_

Your contact information remains private and will only be used for community notifications.

Keeping Citizens Informed – Brought to you by:

